



Safety Manual and General  
Maintenance

# i-Q Series











# i-Q Series

TABLE OF CONTENTS	
TABLE OF CONTENTS .....	2
Manual guidelines .....	3
Notes and Hyperlinks .....	3
Models .....	4
i-Q Series .....	4
Affinity.....	5
Warnings.....	6
Use and Setting Up .....	10
i-Q Range .....	10
Battery and Charger .....	10
Measuring Gas .....	11
Affinity.....	12
Connections .....	12
Connection.....	13
Maintenance.....	14
Tools.....	15
i-Q Series .....	15
Battery Pack Replacement .....	15
Water Filters .....	16
Coin cell replacement (Energizer™ CR2032, 3V) .....	16
Affinity Battery Replacement.....	21
Cleaning and Decontamination.....	22
EU Declaration of Conformity .....	23
i-Q .....	23
Affinity.....	25
UK Declaration of Conformity .....	27
i-Q .....	27
Affinity.....	29
QUICK LINKS.....	30
QED Downloads .....	30
i-Q Help .....	30
Patent Information.....	30

MANUAL GUIDELINES

Any general symbols used on the product can be found in the table below:

Symbol	Description	Symbol	Description
	By placing the CE marking on a product a manufacturer is declaring, on their sole responsibility, conformity with all of the legal requirements, and for the product to be sold within, the European Economic Area (EEA).		By placing the UKCA marking on a product a manufacturer is declaring, on their sole responsibility, conformity with all of the legal requirements, and for the product to be sold within the UK.
	The wheeled bin icon indicates that the product cannot be disposed of through general waste. Separate collection, handling and disposal of waste electrical and electronic equipment and its components is required.		General warning or hazard.
	Refer to Operator's Manual.		For indoor use only.
	Symbol for ATEX certified equipment for potentially explosive atmospheres.		Symbol for IECEx certified equipment for potentially explosive atmospheres.
	Symbol of the agency that assessed the product to applicable standards. A "US" indicates the product meets the applicable US standards and a "C" indicates the product meets the applicable Canadian standards.		

NOTES AND HYPERLINKS

**Note:** Important/useful information and instructions are shown clearly throughout the manual in this format.

Hyperlinks to other sections of this manual, websites, or email addresses will be shown clearly throughout the manual in this format: [www.qedenv.com](http://www.qedenv.com).

# i-Q Series

MODELS  
i-Q SERIES



i-Q™ GEM  
i-Q™ GEM PRO



Ex ib IIA T1 Gb  
(Ta = -10°C to +45°C)  
ExVeritas 23ATEX1559X  
ExVeritas 23UKEX1560X  
IECEx EXV 23.0013X

801503  
CLASS 1, ZONE 1, AEx ib  
IIA T1  
(Ta = -10°C to +45°C)

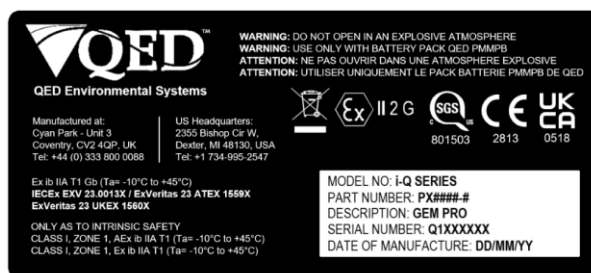

Figure 1 – i-Q Series Marking Plate

**Specific Conditions of Use:**

- This equipment can contain gas sensing heads for the detection of particular gases. The inclusion of a sensor does not infer that the equipment is suitable for the use of gases with a temperature class of less than T1.
- Do not recharge the battery in hazardous locations.
- Only Battery Charger Type iQ-3.9 shall be used to recharge the batteries via the battery charger connector.
- Only a QED Environmental Systems battery pack part number PMMPB is permitted as a replacement.

**Conditions of Acceptability:**

None

AFFINITY



Affinity



Ex ib IIA T1 Gb  
(Ta = -10°C to +50°C)  
ExVeritas 23ATEX1396  
ExVeritas 23UKEX1397  
IECEx EXV 22.0051



801503  
CLASS 1, ZONE 1, AEx ib  
IIA T1  
(Ta = -10°C to +50°C)

QED Environmental Systems

Connector	U <sub>s</sub>	I <sub>s</sub>	P <sub>s</sub>	C <sub>s</sub>	L <sub>s</sub>	C <sub>s</sub>	L <sub>s</sub>
A	5V	3mA	7mW	0µF	0mH	500µF	500mH
B	8.8V	16mA	33mW	2µF	0mH	499µF	500mH
C	8.8V	3mA	6mW	0µF	0mH	500µF	500mH

**WARNING:** USE ONLY WITH ENERGIZER L91 BATTERIES, DO NOT REPLACE BATTERY WHEN AN EXPLOSIVE ATMOSPHERE IS PRESENT  
**ATTENTION:** UTILISER UNIQUEMENT DES BATTERIES ENERGIZER L91. NE PAS REMPLACER LA BATTERIE SI ATMOSPHERE EXPLOSIVE  
Ex ib IIA T1 Gb (Ta = -10°C to +50°C)  
ExVeritas 22 ATEX 1396 / IECEx EXV 22.0051 / ExVeritas 22 UKEX 1397  
ONLY AS TO INTRINSIC SAFETY, CLASS I, ZONE 1, AEx ib IIA T1 (Ta = -10°C to +50°C)

Model: **AFFINITY**  
Serial Number: **V3XXXXXX**  
Date of Manufacture: **DD/MM/YYYY**

Marking plate

Specific Conditions of Use:

None

Conditions of Acceptability:

This product is to be used with only AA Type Energizer™ L91 Cells



# i-Q Series

## WARNINGS

The following warnings are for the setup, use, maintenance, and repair of this equipment. The exclamation point symbol alerts you to a general warning and the hazard symbols refer to procedure-specific risks. When these symbols appear in the body of this manual or on warning labels, refer back to these Warnings. Product-specific hazard symbols and warnings not covered in this section may appear throughout the body of this manual where applicable.

Failure to follow the correct information may result in physical injury which in some cases could be fatal. If the equipment is used in a manner not specified by the manufacturer, the protection provided by the equipment may be impaired.

### **WARNING**



#### **FIRE AND EXPLOSION HAZARD**

Flammable gases, such as methane, in work area can ignite or explode. To help prevent fire and explosion:



- Use equipment only in well-ventilated areas.
- Eliminate all ignition sources; such as pilot lights or cigarettes.
- Do not open the equipment in an explosive atmosphere.
- Where hazardous gases are being used the gas exhausted from the instrument must be piped to an area where it is safe to discharge the gas.
- It is the responsibility of the operator to determine the protection concept and classification of equipment required for a particular application and whether these gases create a potentially explosive atmosphere.



- Do not attempt to charge non-rechargeable batteries.



Static charge may build up on plastic parts during cleaning and could discharge and ignite flammable gases. To help prevent fire and explosion:

- Do not clean with a dry cloth.



## WARNING



### INTRINSIC SAFETY

Intrinsically safe equipment that is improperly used, maintained or connected to non-intrinsically safe equipment will create a hazardous condition and can cause a fire or explosion. Follow local regulations and the following safety requirements.

- Only use QED approved components.
- The equipment may be used with flammable gases and vapours with apparatus group IIA and temperature class T1.
- The equipment can contain gas sensing heads for the detection of particular gases. The inclusion of a sensor does not infer that the equipment is suitable for the use of gases with a temperature class of less than T1.
- The i-Q Series is only certified for use in ambient temperatures in the range -10°C to +45°C and should not be used outside this range.
- Affinity is only certified for use in ambient temperatures in the range -10°C to +50°C and should not be used outside this range.
- The equipment must not be used in an atmosphere of greater than 21% oxygen.
- The equipment must not be used in atmospheric pressure outside of 800mbar to 1100mbar.
- Do not charge, recharge, or open in a potentially explosive atmosphere.
- For the i-Q Series Battery Pack (PMMPB), the maximum input voltage,  $U_m$ , at the battery connector shall not exceed 10.1V.
- Only battery charger type iQ-3.9 shall be used to recharge the battery pack PMMPB.
- Any damage to the equipment that could affect the integrity of the IP65 rating, must be reported to the manufacturer.

For i-Q only:

- Use only with battery pack QED PMMPB.
- Use only with Energizer™ CR2032 battery (QED part number iQ-COINCELL).

For Affinity only:

- Use only Energizer™ L91 batteries.
- Do not replace the battery when an explosive atmosphere is present.
- Do not attempt to charge non-rechargeable batteries.

# i-Q Series

## **WARNING**



### **TOXIC FUMES HAZARD**

The i-Q Series of gas instruments can be used for measuring gases from landfill sites and biogas plants. Toxic gases can cause serious injury or death if inhaled.

- Read Safety Data Sheets (SDSs) to know the specific hazards of the gases you are using.
- Ensure that users are adequately trained in the safety aspects of the gases being used and that appropriate procedures are followed.
- Store hazardous gases in approved containers, and dispose of empty cylinders according to applicable guidelines.
- Ensure hazardous gases are exhausted from the instrument to an area where it is safe to discharge the gas.
- Hazardous gases may be exhausted from the instrument when purging with clean air. Ensure gases are exhausted to an area where it is safe to do so.
- When opening the instrument, do so in a well-ventilated area.



### **PERSONAL PROTECTIVE EQUIPMENT**

Always wear appropriate personal protective equipment (PPE) when using the equipment. Protective equipment helps prevent serious injury, including long-term exposure and inhalation of toxic fumes. Given the applications of intended use, this protective equipment may include, but is not limited to:

- Protective eyewear.
- Hearing protection.
- Protective clothing, such as footwear, gloves, or hard-hat, should be identified through a full risk assessment.



 **WARNING**



**EQUIPMENT MISUSE HAZARD**

Misuse can cause death or serious injury.



- Do not use the equipment when fatigued or under the influence of drugs or alcohol.
- Do not exceed the working parameters outlined in the intrinsic safety warnings.
- The input pressure for the i-Q Range should not exceed +/- 500 mbar relative to atmospheric pressure and the output pressure should not exceed +/- 100 mbar relative to atmospheric pressure.
- Gas instruments are sensitive pieces of scientific equipment and must be treated as such. If the equipment is used in a manner not specified by the manufacturer, the protection provided by the instrument may be impaired.
- If the equipment is likely to be exposed to aggressive substances (e.g. acidic liquids, gases that may attack metals, or solvents that may affect polymeric materials) then it is the responsibility of the user to take suitable precautions. Contact QED or our distributor if there are concerns.
- Do not alter or modify the equipment outside of any instructions provided by QED.
- Only QED approved components are to be used as replacement parts. Alternatives may void agency approvals and create safety hazards.
- The instrument has been designed to be used in explosive atmospheres as defined by the classification. The instrument can be configured to measure low levels of several gases, but may not be certified for use in potentially explosive atmospheres of these gases.
- Use the equipment only for its intended purpose. Contact QED or our distributors for information.
- Repair of this equipment shall be carried out following the applicable code of practice.
- Check equipment for damage before each use. Contact QED or our distributors if there are concerns.
- When the battery is worn out, it must be disposed of under the ordinance of the local authority and not disposed of through general waste.
- Keep children and animals away from the work area.
- Comply with all applicable safety regulations.

**Note:** For further information please contact Technical Support at QED on:

QED Environmental Systems Ltd.

+44(0)333 800 0088

[technical@qedenv.co.uk](mailto:technical@qedenv.co.uk)



QED Environmental Systems, Inc.

+1 (800) 624-2026

[service@qedenv.com](mailto:service@qedenv.com)

# i-Q Series

USE AND SETTING UP  
i-Q RANGE

				
---	---	--	--	--

To prevent fire and explosion:

- Do not charge or open in a hazardous or potentially explosive area.
- Battery Pack QED PMMPB is only for use with i-Q Series.
- Do not attempt to charge non-rechargeable batteries, for example, the Affinity batteries.

BATTERY AND CHARGER

Power Supply	Description
<b>Battery Type</b>	Rechargeable nickel metal hydride battery pack (user replaceable)
<b>Battery Life</b>	Typical use 10 hours from fully charged
<b>Battery charger</b>	Separate intelligent 3A battery charger powered from the mains supply (100-240V)
<b>Charger connector type</b>	2-pin ODU
<b>Charge time</b>	Approximately 4 hours from complete discharge
<b>Charging mode</b>	Connected to the instrument, or standalone

- The PMMPB batteries used are nickel metal hydride and manufactured as a user-replaceable pack containing six individual cells and a PCB.
- The i-Q Series is supplied with a rechargeable battery pack (QED part number PMMPB). Charging of the battery pack can be undertaken while the battery is fitted or removed from the instrument. To charge the battery pack, QED charger iQ-3.9 must be used and charging must be in a safe area.
- Charge only with QED Charger part number iQ-3.9.
- A full charge will take approximately 4-hours.

To charge the battery pack, align the red dot on the charger plug with the red dot on the battery pack socket and plug in until you feel and hear the click of the latching mechanism – see annotation in [Figure 2](#).

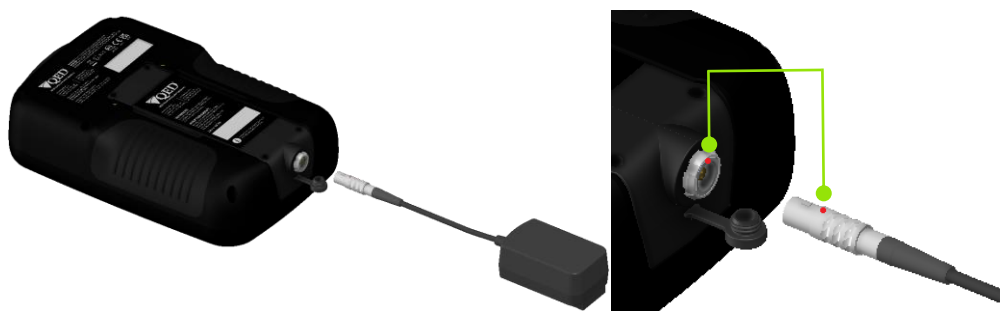

Figure 2 – Charging

**Note:** If the PMMPB battery is removed, the backup coin cell will maintain time/date settings and CO (H<sub>2</sub> compensated) cell conditioning for approximately 10 minutes. After this time, the user will have to reset the time & date and CO (H<sub>2</sub> compensated) cell conditioning will be affected, meaning the user may need to allow the cell to stabilise for 24 hours before use.

MEASURING GAS



To prevent fire and explosion:

- Do not charge or open in a hazardous or potentially explosive area.
- Eliminate all ignition sources; such as pilot lights or cigarettes.

To prevent inhalation of harmful gases:

- Read Safety Data Sheets (SDSs) to know the specific hazards of the gases you are using.
- Ensure that users are adequately trained in the safety aspects of the gases being used and that appropriate procedures are followed.
- Store hazardous gases in approved containers, and dispose of empty cylinders according to applicable guidelines.
- Ensure hazardous gases are exhausted from the instrument to an area where it is safe to discharge the gas.
- Hazardous gases may be exhausted from the instrument when purging with clean air. Ensure gases are exhausted to an area where it is safe to do so.



Figure 3 - i-Q Connections





Figure 4 - i-Q Connection to QED Wellhead

# i-Q Series

Reference	Description	Purpose
1	Gas Inlet	Used to connect the instrument to the monitoring point where gas is to be measured.
2*	Flow Port	GA PRO – Used to connect the instrument to a monitoring point such as a borehole to measure gas flow rate for compliance purposes. GEM PRO and BIOGAS AD PRO – Used to connect the instrument to a monitoring point such as a QED Wellhead to measure the differential pressure and calculate gas flow and power.
3*	Pressure Port	Only available on the GEM PRO, used to connect the instrument to a monitoring point such as a QED Wellhead to measure the system pressure.
4	Gas Exhaust	Measured gas from the gas inlet will exhaust here. It is recommended that a tube is connected to the exhaust and gas is vented to a safe area to protect the user.

**Note:** \* is only available on certain configurations.

## AFFINITY

				
<p>To prevent fire and explosion:</p> <ul style="list-style-type: none"> <li>• Do not open in a hazardous or potentially explosive area.</li> <li>• Eliminate all ignition sources; such as pilot lights or cigarettes.</li> <li>• Only use AA Type Energizer™ L91 batteries.</li> <li>• Do not attempt to charge non-rechargeable batteries, for example, the Affinity batteries.</li> </ul>				

## CONNECTIONS

Various peripherals can be connected to Affinity to measure different parameters, but these peripherals may not be certified or certified appropriately for use in potentially explosive atmospheres. It is the responsibility of the operator to determine the protection concept and classification of equipment required for a particular application and whether these peripherals are suitable for use in a potentially explosive atmosphere.

The instrument has been designed to be used with peripheral accessories that can be connected to the three connection sockets on Affinity, namely Temperature Probe, Anemometer, and Humidity Probe. The entity parameters for these sockets are as follows:

# i-Q Series







Figure 5 - Affinity Connections

Connector	Uo	Io	Po	Ci	Li	Co	Lo
A – Temperature Probe	5V	5mA	7mW	0μF	0mH	500μF	500mH
B – Humidity Probe	8.6V	16mA	33mW	2μF	0mH	499μF	500mH
C – Anemometer Probe	8.6V	3mA	6mW	0μF	0mH	500μF	500mH

## CONNECTION

Affinity connects to the i-Q Series by Bluetooth. To turn Affinity on, press and hold the power key, see Annotation 1 on [Figure 5](#), for two seconds. Pairing is done through the i-Q instrument.

## i-Q Series

MAINTENANCE				
				
<p>To prevent fire and explosion:</p> <ul style="list-style-type: none"><li>• Do not open in a hazardous or potentially explosive area.</li><li>• Only use QED Battery PMMPB for i-Q.</li><li>• Use only Energizer™ CR2032 (QED part number iQ-COINCELL) for backup battery replacement.</li><li>• Only use AA Type Energizer™ L91 batteries for Affinity.</li><li>• Do not attempt to charge non-rechargeable batteries.</li></ul> <p>To avoid misuse hazards:</p> <ul style="list-style-type: none"><li>• Do not alter or modify the equipment outside of any instructions provided by QED.</li><li>• Only QED-approved components are to be used as replacement parts. Alternatives may void agency approvals and create safety hazards.</li><li>• Repair of this equipment shall be carried out following the applicable code of practice.</li><li>• When the battery is ready for disposal, it must be disposed of under the ordinance of the local authority and not disposed of through general waste.</li><li>• Comply with all applicable safety regulations.</li></ul> <p>To avoid toxic fume hazards:</p> <ul style="list-style-type: none"><li>• Open in a well-ventilated area.</li></ul>				

**Note:** For further information please contact Technical Support at QED on:

QED Environmental Systems Ltd.

+44(0)333 800 0088

[technical@qedenv.co.uk](mailto:technical@qedenv.co.uk)

QED Environmental Systems, Inc.

+1 (800) 624-2026

[service@qedenv.com](mailto:service@qedenv.com)



## TOOLS

The i-Q comes supplied with a multi-use tool. This tool can be used on the screws for the i-Q battery, case back, and modules. The driver bit is double-ended and is a Phillips No. 1 and Slotted No. 4.5mm:



Figure 6 - Multi-use Tool

## i-Q SERIES

**Note:** The i-Q Series consists of many replaceable parts. Any replaceable part must be supplied by QED or an authorised representative and will come with a specific set of instructions for its replacement. For technical support, please contact QED or an authorised representative.

For further help, please refer to our i-Q Help Page:



## BATTERY PACK REPLACEMENT

The i-Q battery pack is user replaceable. It can be changed quickly and easily while in the field, including when in a hazardous area. To replace the battery:

- 1) Ensure the unit is switched off.
- 2) Using the supplied Phillips No. 1 screwdriver, unscrew the four battery pack screws and remove them from the case back – see [Figure 7](#).

**Note:** The battery pack screws are retaining and should remain inside the pack.



Figure 7 - Battery Removal

- 3) Place the replacement battery pack (QED part number PMMPB) into the case back recess. It will only fit one way and will automatically align itself.
- 4) Using the supplied tool, select the Phillips No. 1 screwdriver, and secure the battery pack in place.
- 5) i-Q is now ready to be switched on and used.

**Note:** If the PMMPB battery is removed, the backup coin cell will maintain time/date settings and CO (H<sub>2</sub> compensated) cell conditioning for approximately 10 minutes. After this time, the user will have to reset the time & date and CO (H<sub>2</sub> compensated) cell conditioning will be affected, meaning the user may need to allow the cell to stabilise for 24 hours before use.

# Safety Manual and General Maintenance

## i-Q Series

**Note:** It is the operator's responsibility to keep a record of when and what maintenance has been performed.

**Note:** In the event of malfunction or damage, please contact QED or an authorised representative.

**Note:** For further information please contact Technical Support at QED on:

QED Environmental Systems Ltd.

+44(0)333 800 0088

[technical@qedenv.co.uk](mailto:technical@qedenv.co.uk)

QED Environmental Systems, Inc.

+1 (800) 624-2026

[service@qedenv.com](mailto:service@qedenv.com)

### WATER FILTERS



Q iQV14

Each inlet port has a PTFE filter to stop liquid from entering the instrument:

- 1) Using the supplied tool, select the Phillips No. 1 screwdriver and unscrew the 4 faceplate screws
- 2) Gently lift the faceplate away from the case, while keeping it parallel to the top of the case

**Note:** Filters firmly located in the i-Q body can be removed using the supplied filter removal tool.

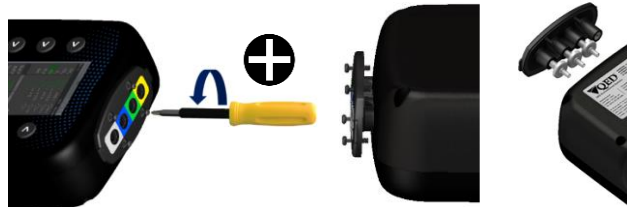

- 3) Replace the filters by placing them inside the faceplate.
- 4) To reassemble, follow the above steps in reverse order, paying attention to the good fit of mating components and taking care not to overtighten any screws.

### COIN CELL REPLACEMENT (ENERGIZER™ CR2032, 3V)



To prevent fire and explosion:

- Do not open in a hazardous or potentially explosive area.
- Use only Energizer™ CR2032 (QED part number iQ-COINCELL) for backup battery replacement.

To avoid misuse hazards:

- Do not alter or modify the equipment outside of any instructions provided by QED.
- Only QED-approved components are to be used as replacement parts. Alternatives may void agency approvals and create safety hazards.
- Repair of this equipment shall be carried out following the applicable code of practice.

- When the battery is ready for disposal, it must be disposed of under the ordinance of the local authority and not disposed of through general waste.
- Comply with all applicable safety regulations.
- It is the operator's responsibility to keep a record of when and what maintenance has been performed.
- In the event of malfunction or damage, please contact QED or an authorised representative.



🔍 iQV15

The internal coin cell battery will retain the current time & date and compensated cell bias for a short time if the primary battery pack is removed. If the coin cell registers as “missing” due to insufficient charge, it should be replaced.

To replace the coin cell:

- 1) Using the supplied Phillips No. 1 screwdriver, unscrew the four battery pack screws and remove them from the case back – see [Figure 7](#).

**Note:** The battery pack screws are retaining and should remain inside the pack.

- 2) Using the Phillips No. 1 screwdriver, loosen the inlet port plate screws and gently ease from the case assembly using the plate ears, see [Figure 8](#).

**Note:** The plate only needs loosening and does not require removal.

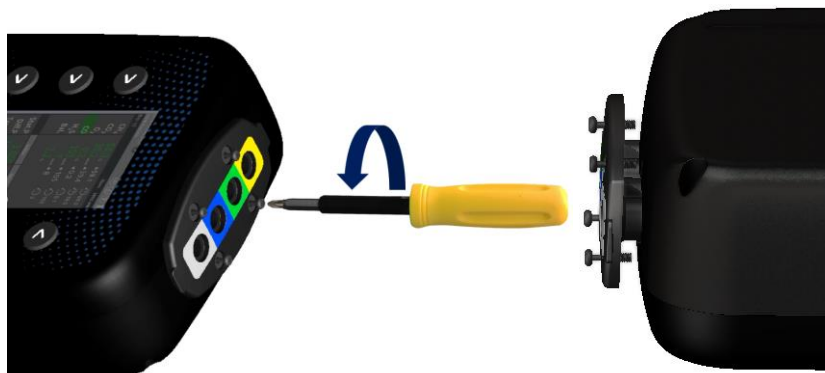

Figure 8 – Inlet Port Plate Removal

## i-Q Series

- Using the Phillips No. 1 screwdriver, remove the 8 screws from the case back and gently remove the case back from the case front to have access to the internals of the i-Q.



Figure 9 - Case Back Removal

**Note:** Internals of i-Q will vary depending on the configuration.

**Note:** The case back screws are retaining and should remain inside the case back.

- Simply lift the pressure module from its location to gain access to the coin cell – see annotation 1 in [Figure 10](#).

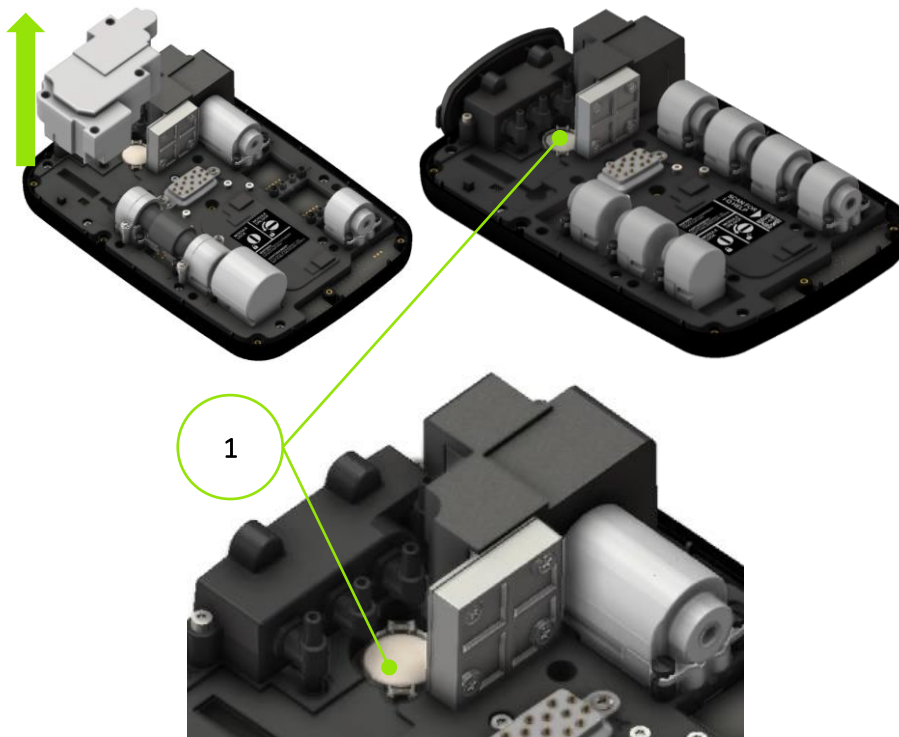

Figure 10 – Pressure Module Removal

## i-Q Series

- 5) Using the spudger supplied with the replacement coin cell, lift the old coin cell out of its cradle



Figure 11 – Coin Cell Removed

- 6) Fit the new coin cell, ensuring correct orientation, with the positive terminal (+) facing upwards



Figure 12 – Coin Cell Orientation

- 7) Replace the pressure module, ensuring the connector on the Carrier PCB aligns with the socket on the base of the module.

**Note:** Care is to be taken when aligning

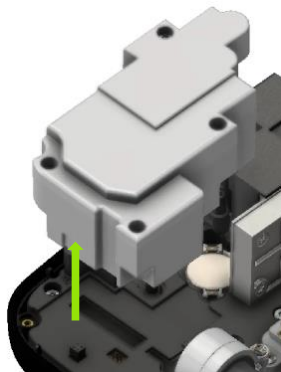

Figure 13 – Pressure Module Alignment

## i-Q Series

- 8) Replace the case back and secure it in place with the retained screws and the Phillips No.1 screwdriver



Figure 14 – Case Back Fitting

- 9) Tighten the inlet port plate screws using the Phillips No.1 screwdriver



Figure 15 – Inlet Port Plate Fitting

- 10) Place the replacement battery pack (QED part number PMMPB) into the case back recess. It will only fit one way and will automatically align itself.
- 11) Using Phillips No. 1 screwdriver, secure the battery pack in place.



Figure 16 – Battery Fitting

- 12) i-Q is now ready to be switched on and used.

**Note:** If the PMMPB battery is removed, the backup coin cell will maintain time/date settings and CO (H<sub>2</sub> compensated) cell conditioning for approximately 10 minutes. After this time, the user will have to reset the time & date and CO (H<sub>2</sub> compensated) cell conditioning will be affected, meaning the user may need to allow the cell to stabilise for 24 hours before use.



**Note:** It is the operator's responsibility to keep a record of when and what maintenance has been performed.

**Note:** In the event of malfunction or damage, please contact QED or an authorized representative.

**Note:** For further information please contact Technical Support at QED on:

QED Environmental Systems Ltd.

+44(0)333 800 0088

[technical@qedenv.co.uk](mailto:technical@qedenv.co.uk)

QED Environmental Systems, Inc.

+1 (800) 624-2026

[service@qedenv.com](mailto:service@qedenv.com)

### AFFINITY BATTERY REPLACEMENT

The batteries in Affinity are user replaceable. When the batteries are getting low, the LED on the Affinity keypad will flash red slowly (see annotation 1 on [Figure 17](#)). When the battery is critically low, the LED in the Affinity keypad will flash red rapidly.



Figure 17 - Affinity

To replace the Affinity batteries:

- 1) Using the supplied Phillips No. 1 screwdriver, unscrew the two screws on the battery cover found on the rear of the case, and remove them – see [Figure 18](#).

**Note:** The battery cover screws are retaining and should remain inside the cover.



Figure 18 - Affinity Battery Access

- 2) Remove the old batteries and dispose under the ordinance of the local authority.

## Safety Manual and General Maintenance

### i-Q Series

3) Replace with 2 x AA Type Energizer™ L91 cells.

**Note:** *Ensure the correct orientation of batteries.*

4) Replace the battery cover and using Phillips No. 1 screwdriver, secure the cover in place.

5) Affinity is now ready to be switched on and paired with an i-Q instrument.

**Note:** *It is the operator's responsibility to keep a record of when and what maintenance has been performed.*

**Note:** *In the event of malfunction or damage, please contact QED or an authorised representative.*

#### CLEANING AND DECONTAMINATION

The equipment must have its battery removed before cleaning or decontamination. The enclosure can be cleaned externally using mild soapy water and a non-abrasive cloth.

Should the need arise for the i-Q instrument to be returned to QED, it is the responsibility of the owner to ensure that the instrument has been decontaminated or that QED has been made aware of any contaminants that may be present, before it being returned.

EU DECLARATION OF CONFORMITY

i-Q



## EU Declaration of Conformity

This Declaration of Conformity is issued under the sole responsibility of the manufacturer:

QED Environmental Systems  
 Cyan Park – Unit 3  
 Jimmy Hill Way  
 Coventry  
 CV2 4QP  
 UNITED KINGDOM

**Product:** i-Q™ Series

- GEM
- GEM PRO

**Type of equipment:** Gas analyser for gas extraction management on a landfill site.



The i-Q™ Series described above is in conformity with the relevant Union harmonisation legislation:

2014/34/EU: Equipment and protective systems intended for use in potentially explosive atmospheres (ATEX)

ExVeritas (2804) performed assessment against:

- EN IEC 60079-0:2018
- EN 60079-11:2012

Issuing certificate number ExVeritas 23ATEX1559X.

2014/53/EU: Radio equipment (RED)

TUV SUD [0123] performed assessment against:

**Radio Spectrum (Article 3.2):**

- ETSI EN 300 328 : V2.2.2 (2019-07)

**EMC (Article 3.1b):**

- ETSI EN 301 489-1 : V2.2.3 (2019-11)
- EN 61326-1 : 2021
- EN61000-3-2 : 2019
- EN 61000-3-3 : 2013 A1: 2019
- ETSI EN 301 489-17 : V3.2.4 (2020-09)

**Health and Safety (Article 3.1a):**

- IEC 62368-1:2014
- IEC 61010-1:2010/AMD1:2016
- EN 62311:2008
- EN 50663:2017

[www.qedenv.com](http://www.qedenv.com)

MISC0201-iQ Iss.01  
 © QED Environmental Systems Ltd.

# i-Q Series



In addition, the following International requirements are met:



International Electrotechnical Commission system for certification to standards relating to equipment for use in explosive atmospheres (IECEx System)

ExVeritas performed assessment against:

- IEC 60079-0:2017 Edition 7
- IEC 60079-11:2011 Edition 6

Issuing certificate number IECEx EXV 23.0013X.

2011/65/EU: Restriction of Hazardous Substances in Electrical and Electronic Equipment (RoHS)

Signed for and on behalf of:

**Name:** Mr. Craig Millar

**Position:** Engineering Manager

**Done at:** QED Environmental Systems

**On:** 21<sup>st</sup> August 2023



## EU Declaration of Conformity

This Declaration of Conformity is issued under the sole responsibility of the manufacturer:

QED Environmental Systems  
 Cyan Park – Unit 3  
 Jimmy Hill Way  
 Coventry  
 CV2 4QP  
 UNITED KINGDOM

**Product:** Affinity

**Type of equipment:**  
 Wireless sensor transmitter for i-Q Series peripherals



The Affinity described above is in conformity with the relevant Union harmonisation legislation:

2014/34/EU: Equipment and protective systems intended for use in potentially explosive atmospheres (ATEX)

ExVeritas (2804) performed assessment against:

- EN IEC 60079-0:2018
- EN IEC 60079-11:2012

Issuing certificate number ExVeritas 22ATEX1396.

2014/53/EU: Radio equipment (RED)

TUV SUD [0123] performed assessment against:

**Radio Spectrum (Article 3.2):**

- ETSI EN 300 328 : V2.2.2 (2019-07)

**EMC (Article 3.1b):**

- ETSI EN 301 489-1 : V2.2.3 (2019-11)
- EN 61326-1 : 2021
- EN61000-3-2 : 2019
- EN 61000-3-3 : 2013 A1: 2019
- ETSI EN 301 489-17 : V3.2.4 (2020-09)

**Health and Safety (Article 3.1a):**

- IEC 62368-1:2014
- IEC 61010-1:2010/AMD1:2016

[www.qedenv.com](http://www.qedenv.com)

MISC0201-AFFINITY Iss.01  
 © QED Environmental Systems Ltd.

# i-Q Series



- EN 62311:2008
- EN 50663:2017

In addition, the following International requirements are met:

 International Electrotechnical Commission system for certification to standards relating to equipment for use in explosive atmospheres (IECEx System)

ExVeritas performed assessment against:

- IEC 60079-0:2017 Edition 7.0
- IEC 60079-11:2011 Edition 6.0

Issuing certificate number IECEx EXV 22.0051.

Signed for and on behalf of:

Name: Mr. Craig Millar

Position: Engineering Manager

Done at: QED Environmental Systems

On: 21<sup>st</sup> February 2023





## UKCA Declaration of Conformity

This Declaration of Conformity is issued under the sole responsibility of the manufacturer:

QED Environmental Systems  
 Cyan Park – Unit 3  
 Jimmy Hill Way  
 Coventry  
 CV2 4QP  
 UNITED KINGDOM

**Product:** i-Q™ Series

- GEM
- GEM PRO

**Type of equipment:** Gas analyser for gas extraction management on a landfill site.



The i-Q™ Series described above is in conformity with the relevant legislation of the United Kingdom:

**Equipment and Protective Systems Intended for use in Potentially Explosive Atmospheres Regulations 2016**

ExVeritas (2585) performed assessment against:

- EN IEC 60079-0:2018
- EN 60079-11:2012

Issuing certificate number ExVeritas 23UKEX1560X.

**Radio Equipment Regulations 2017**

TUV SUD [0123] performed assessment against:

**Radio Spectrum (Article 3.2):**

- ETSI EN 300 328 : V2.2.2 (2019-07)

**EMC (Article 3.1b):**

- ETSI EN 301 489-1 : V2.2.3 (2019-11)
- EN 61326-1 : 2021
- EN61000-3-2 : 2019
- EN 61000-3-3 : 2013 A1: 2019
- ETSI EN 301 489-17 : V3.2.4 (2020-09)

**Health and Safety (Article 3.1a):**

- IEC 62368-1:2014
- IEC 61010-1:2010/AMD1:2016
- EN 62311:2008
- EN 50663:2017

# i-Q Series



UKCA Declaration of Conformity

Page 2 of 2

The Restriction of the Use of Certain Hazardous Substances in Electrical and Electronic Equipment Regulations 2012

Signed for and on behalf of:

A handwritten signature in black ink, appearing to read 'C. Millar'.

**Name:** Mr. Craig Millar

**Position:** Engineering Manager

**Done at:** QED Environmental Systems

**On:** 21<sup>st</sup> August 2023



## UK Declaration of Conformity

This Declaration of Conformity is issued under the sole responsibility of the manufacturer:

QED Environmental Systems  
 Cyan Park – Unit 3  
 Jimmy Hill Way  
 Coventry  
 CV2 4QP  
 UNITED KINGDOM

**Product:** Affinity

**Type of equipment:** Wireless sensor transmitter for i-Q Series peripherals



The Affinity described above is in conformity with the relevant legislation of the United Kingdom:

Equipment and Protective Systems Intended for use in Potentially Explosive Atmospheres Regulations 2016

ExVeritas (2585) performed assessment against:

- EN IEC 60079-0:2018
- EN 60079-11:2012

Issuing certificate number ExVeritas 22UKEX1397.

Radio Equipment Regulations 2017

TUV SUD [0123] performed assessment against:

**Radio Spectrum (Article 3.2):**

- ETSI EN 300 328 : V2.2.2 (2019-07)

**EMC (Article 3.1b):**

- ETSI EN 301 489-1 : V2.2.3 (2019-11)
- EN 61326-1 : 2021
- EN61000-3-2 : 2019
- EN 61000-3-3 : 2013 A1: 2019
- ETSI EN 301 489-17 : V3.2.4 (2020-09)

**Health and Safety (Article 3.1a):**

- IEC 62368-1:2014
- IEC 61010-1:2010/AMD1:2016
- EN 62311:2008
- EN 50663:2017

Signed for and on behalf of:

**Name:** Mr. Craig Millar

**Position:** Engineering Manager

**Done at:** QED Environmental Systems

**On:** 21st February 2023

[www.qedenv.com](http://www.qedenv.com)

MISCO200-AFFINITY Iss.01  
 © QED Environmental Systems Ltd.

## i-Q Series

QUICK LINKS

QED DOWNLOADS



i-Q HELP



PATENT INFORMATION

The equipment in this manual is protected under U.S. and foreign patents issued and pending. For a complete list of patents visit [www.graco.com/patents](http://www.graco.com/patents).

The equipment in this manual is protected under Registered Trademarks. For a complete list of Registered Trademarks and Trademarks, visit [www.graco.com/trademarks](http://www.graco.com/trademarks).



Safety Manual and General Maintenance

## i-Q Series



# i-Q Series

## Safety Manual and General Maintenance



### OMIQSAFETY - Issue.02

[www.qedenv.com](http://www.qedenv.com)

QED Environmental Systems Inc.

2355 Bishop Circle West

Dexter, MI 48130 - 1592

1 (800) 624 – 2026

[info@qedenv.com](mailto:info@qedenv.com)

QED Environmental Systems Ltd.

Unit 3 – Cyan Park

Coventry

United Kingdom

+44 (0) 333 800 0088

[sales@qedenv.co.uk](mailto:sales@qedenv.co.uk)