

# Geotech

## BIOGAS 3000



### OPERATING MANUAL



## Operating Manual

### TABLE OF CONTENTS

Manual guidelines .....	5
Safety symbol .....	5
Hyperlinks .....	5
Notes .....	5
Safety information .....	6
Safety instructions .....	6
Certification .....	7
Range of environmental conditions .....	9
Safety symbols used on the instrument .....	10
BIOGAS 3000 Overview .....	11
Features .....	11
Benefits .....	12
Options .....	12
Main Applications .....	12
Model Type Definitions .....	13
BIOGAS 3000 Internal Components .....	17
BIOGAS 3000 Module Features .....	19
Physical Characteristics of the Module .....	19
Definitions .....	20
Installation .....	22
Pre-Installation Requirements .....	22
External Customer Connections .....	24
Mounting the Enclosure .....	25
Connecting the Gas Lines to the BIOGAS 3000 .....	26
Drain .....	28
Protective Cover .....	30
Cable Gland Selection and Cord Anchorage .....	31
Cable Conductor Sizes and Insulation Requirements .....	32
Mains Wiring .....	32
Modbus Digital Output .....	35

## Operating Manual

4-20mA Outputs .....	43
Relays .....	47
Profibus Digital Output .....	48
Profinet Digital Output.....	56
Ethernet Digital Output.....	62
Wiring the Ethernet Input.....	69
Heater Option .....	70
Final Checks .....	71
<b>General Operating Instructions.....</b>	<b>72</b>
Switching the BIOGAS 3000 System On .....	72
System Start-Up .....	72
Help Function.....	75
First Time Configuration .....	76
Gas Readings Screen .....	78
Alarms .....	82
Stop Sampling .....	84
Menu.....	85
BIOGAS 3000 Sampling Process .....	113
<b>Gas Check and Calibration .....</b>	<b>116</b>
Introduction .....	116
Required Equipment .....	116
Gas Mixtures .....	117
Connecting a Gas Bottle to the BIOGAS 3000 .....	121
Gas Check and Calibration .....	123
Status Icons.....	125
Disconnecting a Gas Bottle from the BIOGAS 3000 .....	126
<b>Maintenance.....</b>	<b>128</b>
Maintenance Schedule .....	128
BIOGAS 3000 Consumable Products.....	130
Emptying the Catchpot .....	132
Replacing the Catchpot Filter.....	135

## Operating Manual

Replacing the Inline PTFE Filter .....	139
Pressure Test.....	142
Cleaning and Decontamination.....	149
<b>Service.....</b>	<b>150</b>
General .....	150
Service Notifications .....	150
Replacement BIOGAS 3000 Module for Service – Hot Swap .....	150
<b>Problem Solving .....</b>	<b>153</b>
Fault Detection .....	153
System Will Not Power On.....	155
Module Will Not Power On.....	155
Module Lock-Up.....	156
Under and Over Range Codes .....	156
Analogue Outputs Not Working.....	156
Modbus Outputs Not Working.....	157
Low Flow / Flow Fail.....	157
Fuses .....	158
User Calibration Explained.....	159
<b>BIOGAS 3000 Warranty Terms and Conditions .....</b>	<b>162</b>
<b>WEEE Compliance .....</b>	<b>164</b>
<b>Declaration of Conformity.....</b>	<b>165</b>
<b>Glossary of Terms .....</b>	<b>167</b>

## Operating Manual

### MANUAL GUIDELINES

#### Safety symbol

Information in this manual that may affect the safety of users and others is in the following format:



Information in this manual that may affect the safety of users and others will be in a box identical to this one.

Failure to follow this information may result in physical injury that in some cases could be fatal, cause damage to the equipment or to the environment, or invalidate the certification of the equipment.

#### Hyperlinks

Hyperlinks to other sections of this manual, websites or email addresses are in the following format:

[www.geotechuk.com](http://www.geotechuk.com)

#### Notes

Important/useful information and instructions are shown clearly throughout the manual in a note format.

For example:

Note: For further information please contact Technical Support at QED on +44(0)333 800 0088 or email [technical@qedenv.co.uk](mailto:technical@qedenv.co.uk).

## Operating Manual

### SAFETY INFORMATION

#### Safety instructions

The BIOGAS 3000 comes with a guard that covers all accessible components with mains power. This guard must only be removed when power to the system is isolated. Failure to isolate the supply could result in an electric shock.

When opening the cabinet great care must be taken by the operator as mains voltages are present. It is the responsibility of the owner of the equipment to ensure that all personnel are adequately trained.

It is the responsibility of the owner of this equipment to complete a risk assessment on its installation, operation, and maintenance prior to it being used.

Anti-static precautions should be observed during installation, maintenance, and general operation of the equipment.



Inhaling toxic gases may be harmful to health and in some cases may be fatal. It is the responsibility of the user to ensure that he/she is adequately trained in the safety aspects of the gases being used and appropriate procedures are followed. In particular, where hazardous gases are being used, the gas exhausted from the system must be piped to an area where it is safe to discharge the gas, or returned to the process.

The equipment should not be altered in any way other than described within this operating manual. Alterations or changes outside of this operating manual could make the equipment unsafe and invalidate the hazardous area certification.

It is vital that the instructions in this operating manual are followed closely. Failure to comply could cause an injury to the operator.

The auto-drain pump will need replacing before 4,000 hours use. At 3,000 hours, a non-critical fault will appear on screen to advise the user that replacement is due. At 4,000 hours, a critical fault will occur and stop the system from operating until replaced.

- Suitably trained personnel should carry out the installation in accordance with the applicable code of practice.
- Repair and maintenance of this equipment should be carried out in accordance with the applicable code of practice and this operating manual.
- Only QED approved components are to be used as replacement parts.
- If the equipment is likely to be exposed to aggressive substances (e.g. acidic liquids, gases that may attack metals or solvents that may affect polymeric materials) then it is the responsibility of the user to take suitable precautions, e.g. regular checks are performed as part of routine inspections or establishing from the material's datasheet that it is chemically resistant.

**Note:** For further information please contact Technical Support at QED on +44(0)333 800 0088 or email [technical@qedenv.co.uk](mailto:technical@qedenv.co.uk).

## Operating Manual

### Certification



The equipment is designed for use in potentially explosive atmospheres as defined by the classification. The equipment can be configured to measure low levels of several gases, but may not be certified for use in potentially explosive atmospheres of these gases. It is the responsibility of the operator to determine the protection concept and classification of equipment required for a particular application and if these gases create a potentially explosive atmosphere.

The equipment should not be altered in any way other than described within this operating manual. Alterations or changes outside of this operating manual will invalidate the certification and could make the apparatus unsafe.

### ATEX and IECEx Certification

In reference to European ATEX Directive 2014/34/EU and the IECEx International Certification Scheme, the BIOGAS 3000 has been certified according to the following designation:



Ex nA nC IIA T1 Gc (-20°C ≤ Ta ≤ +50°C)

### Instructions Specific to Hazardous Area Installations

- 1) The equipment may be used in zones 2 with flammable gases and vapours with apparatus groups IIA and with temperature classes T1.
- 2) The equipment is only certified for use in ambient temperatures in the range -20°C to +50°C and should not be used outside this range.
- 3) Installation shall be carried out in accordance with the applicable code of practice by suitably trained personnel.
- 4) There is no special checking or maintenance conditions other than a periodic check.
- 5) With regard to explosion safety, it is not necessary to check for correct operation.
- 6) The equipment contains no user-replaceable parts and is not intended to be repaired by the user. Repair of the equipment is to be carried out by the manufacturer, or their approved agents, in accordance with the applicable code of practice.

**Note:** Please contact our technical support team at QED on +44(0)333 800 0088 or email [technical@qedenv.co.uk](mailto:technical@qedenv.co.uk) to receive training on repairing the equipment and becoming an approved repair agent.

- 7) Repair of this equipment shall be carried out in accordance with the applicable code of practice.
- 8) If the equipment is likely to come into contact with aggressive substances, e.g. acidic liquids or gases that may attack metals or solvents that may affect polymeric materials, then it is the

## Operating Manual

responsibility of the user to take suitable precautions that prevent it from being adversely affected thus ensuring that the type of protection is not compromised.

- 9) The certificate number has an 'X' suffix, which indicates that special conditions of installation and use apply. Those installing or inspecting this equipment must have access to the contents of the certificate or these instructions. The conditions listed in the certificate are reproduced below:
  - All cable entry holes shall be fitted with either a certified cable gland or a certified stopping plug with minimum IP65 that is suitable for the application.
  - The equipment may only be used in areas with a low risk of mechanical impact.
  - Warning – in locations where high external humidity and internal temperature variations (e.g. frequent on-off cycles) may cause condensation inside the equipment, the interior should be periodically inspected.
  - The terminal blocks shall only be fitted with wires that have cross sectional area falling within the terminal blocks certificates limitations and any unused terminals shall be tightened. Refer to [Cable Conductor Sizes](#).
  - Equipment has only been assessed for electrical safety. No non-electrical assessment has been conducted and the manufacturer declares compliance for this under his own responsibility.
- 10) Cell replacement must only be carried out in the safe area or when a hazardous atmosphere is not present.

**Note:** Additional instructions shall be supplied alongside any replacement cell related to the specific installation requirements.

**Note:** Regarding the use of covers, jumpers, cross connectors, end brackets, or any other accessories of the terminals, the instructions of the manufacturer must be followed.

### Entity Parameters

The following ratings must not be exceeded on the listed circuits below:

Circuit	Ur (rated voltage)	Ir (rated current)	Pr (rated power)
Relay coil	24Vdc	6A	144W
4-20mA	24Vdc	20mA	480mW
RS485 Modbus	-7 to +12V	83.3mA	417mW
Ethernet	2.5Vdc	25mA	63mW



## Operating Manual

### Marking

In reference to European ATEX Directive 2014/34/EU and the IECEx International Certification Scheme, [Nameplate 1](#) can be found on the main enclosure of the system:

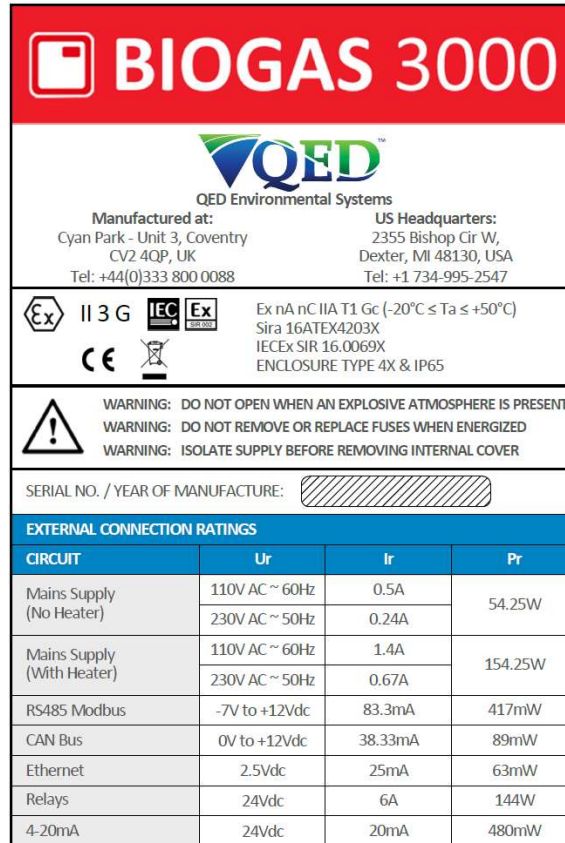

Nameplate 1 - BIOGAS 3000 markings

### Range of environmental conditions

- The system is only for use in ambient temperatures in the range of 0°C to 50°C without the use of the approved heater, and -20°C to 50°C with the use of the approved heater.
- The BIOGAS 3000 is designed for use outdoors and has an IP65 rating.
- The mains voltages (110-230V) can fluctuate up to ±10% of the nominal voltage.
- Transient Overvoltages up to the levels of 2500V (Overvoltage Category II)
- Temporary overvoltages occurring on the mains supply must not exceed +1200V short term and +250V long term
- Pollution degree 3 rating.
- The system is only for use in the humidity range of 0-95% RH non-condensing.
- The system is only for use in ambient pressures in the range 700 to 1200mbar. 700mbar equates to a maximum altitude of nominally 3,000 metres above sea level.

## Operating Manual



If the equipment is used in a manner not specified by the manufacturer, the protection provided by the equipment may be impaired.

### Safety symbols used on the instrument

The following safety symbols are used on the BIOGAS 3000:

	Protective conductor terminal
	Caution, risk of electric shock
	Function earth (ground) terminal
	Caution
	Caution, risk of hot surface



Where the symbol or is used in the BIOGAS 3000, the operating manual must be consulted.

## Operating Manual

### BIOGAS 3000 OVERVIEW

#### Features



The BIOGAS 3000, primarily for the AD Biogas and Bio-methane upgrading market has been designed to enable site operations to maximise gas production yield and protect expensive capital equipment from the damaging contaminant gases contained within the production process. The ATEX and IECEx certified BIOGAS 3000 builds on field proven, robust gas analysis technology to offer cost effective online monitoring with local data outputs.

- CH<sub>4</sub>, CO<sub>2</sub> & O<sub>2</sub> – standard measurements
- H<sub>2</sub>S, H<sub>2</sub> and CO – optional measurements (choice of up to two)
- Modular design enabling hot-swap for serviceability and onsite maintenance
- User calibration function to maintain accuracy and ensure data reliability in extreme temperatures
- ATEX and IECEx certified for use in potentially explosive gas atmospheres – Zone 2
- ISO/IEC 17025 calibration for optimal accuracy
- Ability to monitor the gas control process before and after desulphurisation
- Continuous monitoring option
- Up to 4 sample points to monitor the complete gas control process
- Internet connectivity allowing remote access to data and settings, process control, calibration, firmware updating and remote technical support
- Gas return to process as standard
- IP65 rated for weatherproofing
- Built-in liquid level monitoring with a dedicated alarm to inform the user contents of the catchpot require emptying or an optional automated moisture removal drain

## Operating Manual

- Gas alarms and fault notifications
- 6 x 4-20mA outputs
- Modbus RTU communication
- Optional Profibus and Profinet communication
- Clear, visual and informative colour display
- Optional heater to extend operating temperature range to -20°C
- Multi-lingual product with literature and technical support now available in German, Spanish, French, Italian, Polish, Chinese, and English.
- Extended Warranty and Service pack options through approved global service centres

### Benefits

- Customisable to site requirements
- Zero operational downtime for servicing
- Product reliability and longevity
- Protect expensive capital equipment from damaging gases
- Maximise operational efficiency through optimising the AD process
- Operational within hazardous areas
- Ease of operation, integration and installation
- Minimal through-life costs
- Local support for peace of mind

### Options

- H<sub>2</sub>S ranges from 0-50ppm to 0-40,000ppm
- CO 0-1,000ppm
- H<sub>2</sub> 0-1,000ppm
- Profibus replaces Modbus
- Profinet replaces Modbus
- 110V or 230V heater
- Auto-drain to empty contents of catchpot without user interaction
- Hydrolysis tank measurement option to improve the life of the external sensor, if required

### Main Applications

- AD research

## Operating Manual

- Agricultural waste AD (large scale)
- Biogas upgrading
- Farm waste AD (small scale)
- Gas flaring
- Mixed food waste AD
- Sewage / waste water treatment AD

### Model Type Definitions

#### BG3K1

- The BG3K1 measures CH<sub>4</sub>, CO<sub>2</sub>, and O<sub>2</sub> as standard with a choice of up to two additional gases (one internal to the module and one external) and measures from one sample point.
- It has user selectable sample and air purge intervals that are exhausted back to the process and atmosphere respectively.
- The 4-20mA and Modbus outputs are updated at the end of each sample.
- The following image is a simple block diagram of the system including the optional external gas sensor:

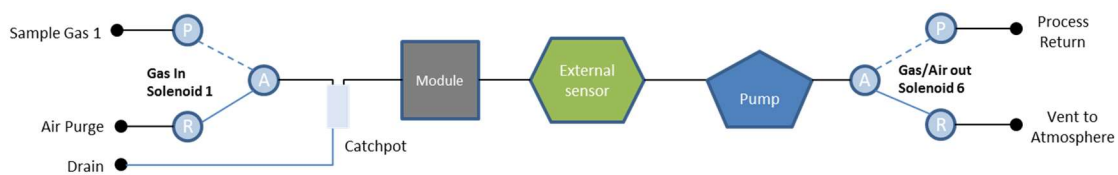

#### BG3K2

- The BG3K2 measures CH<sub>4</sub>, CO<sub>2</sub>, and O<sub>2</sub> as standard with a choice of up to two additional gases (one internal to the module and one external) and measures from two sample points.
- It has user selectable sample and air purge intervals that are exhausted back to the process and atmosphere respectively.
- The 4-20mA and Modbus outputs are updated at the end of each sample.
- The following image is a simple block diagram of the system including the optional external gas sensor:

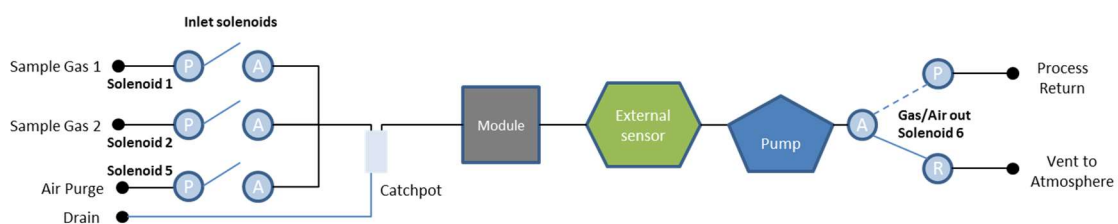

## Operating Manual

### BG3K3

- The BG3K3 measures CH<sub>4</sub>, CO<sub>2</sub>, and O<sub>2</sub> as standard with a choice of up to two additional gases (one internal to the module and one external) from three sample points.
- It has user selectable sample and air purge intervals that are exhausted back to the process and atmosphere respectively.
- The 4-20mA and Modbus outputs are updated at the end of each sample.
- The following image is a simple block diagram of the system including the optional external gas sensor:

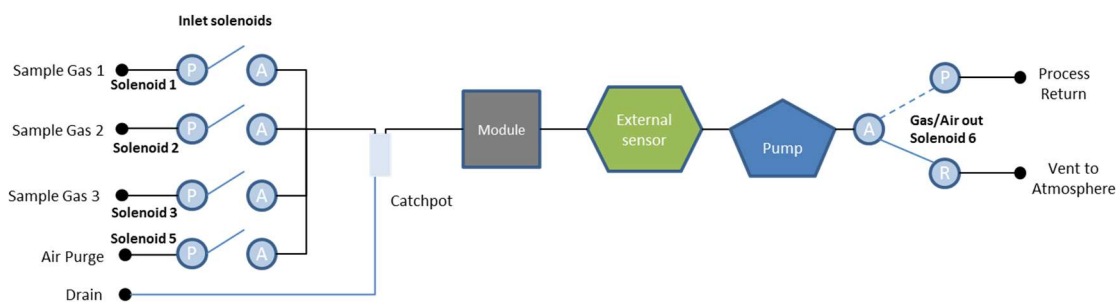

- The BG3K3 also has the option of measuring from the hydrolysis tank on sample point 1 and not passing this gas across the external sensor. This prolongs the life of the sensor. The following image is a block diagram if the system with this option selected:

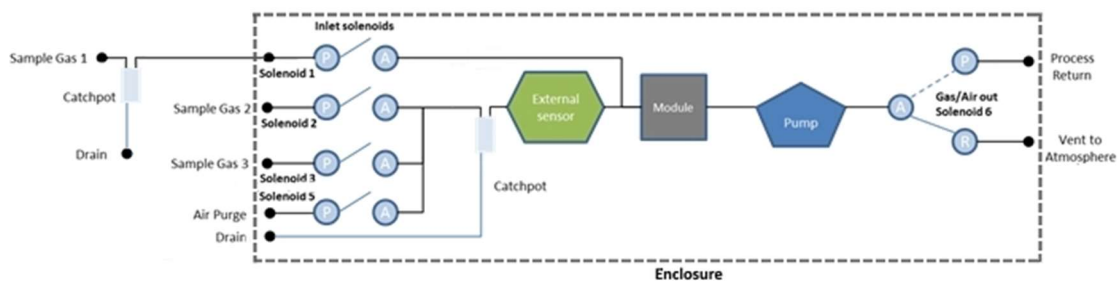

Note: For this option, you will need to fit the additional moisture filter supplied on 'Sample Gas 1'.

### BG3K4

- The BG3K4 measures CH<sub>4</sub>, CO<sub>2</sub>, and O<sub>2</sub> as standard with a choice of up to two additional gases (one internal to the module and one external) from four sample points.
- It has user selectable sample and air purge intervals that are exhausted back to the process and atmosphere respectively.
- The 4-20mA and Modbus outputs are updated at the end of each sample.
- The following image is a simple block diagram of the system including the optional external gas

## Operating Manual

sensor:

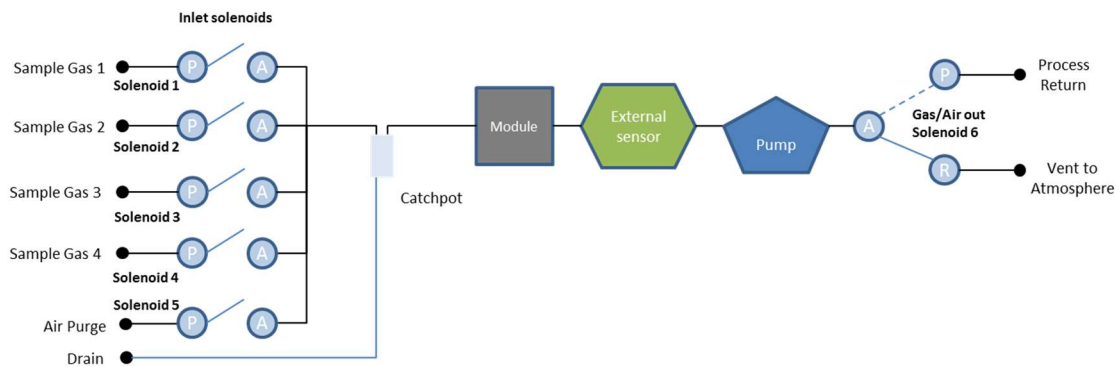

- The BG3K4 also has the option of measuring from the hydrolysis tank on sample point 1 and not passing this gas across the external sensor. This prolongs the life of the sensor. The following image is a block diagram if the system with this option selected:

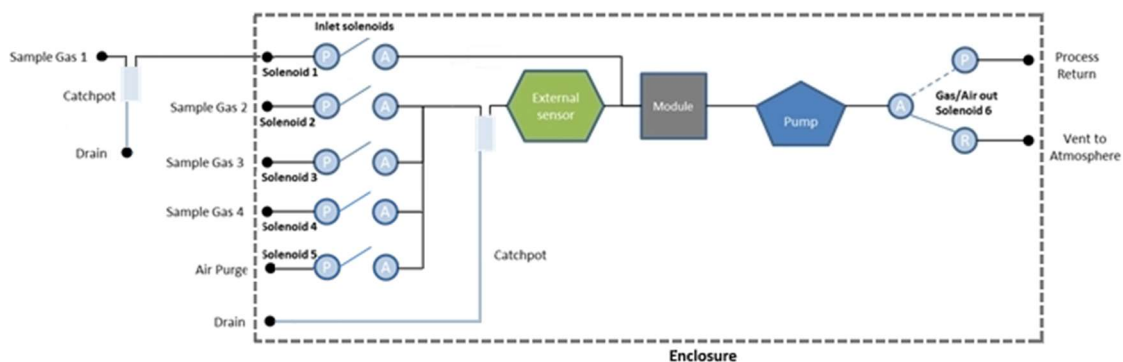

Note: For this option, you will need to fit the additional moisture filter supplied on 'Sample Gas 1'.

### BG3KD

- The BG3KD measures CH<sub>4</sub>, CO<sub>2</sub>, O<sub>2</sub> and high and low range H<sub>2</sub>S as standard (high range internal to the module and low range external) from two sample points.
- It has user selectable sample and air purge intervals that are exhausted back to the process and atmosphere respectively.
- The system has bypass solenoids in order to divert high levels of H<sub>2</sub>S from the low range sensor, which will prolong its life.
- The 4-20mA and Modbus outputs are updated at the end of each sample.
- The following image is a simple block diagram of the system:

## Operating Manual

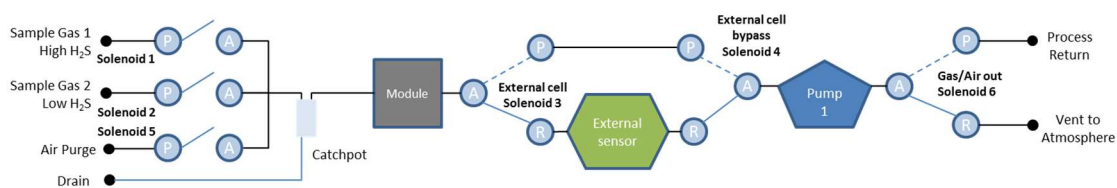

### BG3KE

- The BG3KE measures CH<sub>4</sub>, CO<sub>2</sub>, and O<sub>2</sub> as standard with a choice of up to one additional gas (external to module only) from one sample point.
- It measures CH<sub>4</sub>, CO<sub>2</sub>, and O<sub>2</sub> continuously that is exhausted back to the process.
- The module has a minimum three-minute air purge every 24-hours. The duration and time of day this occurs is user-definable.
- The external sensor has user selectable sample intervals that are exhausted back to the process. The external sensor cannot be subjected to the gas stream continuously.
- After each defined cycle, the external sensor is subjected to a user definable air purge that is exhausted to the atmosphere.
- The 4-20mA and Modbus outputs are updated continuously, with the external sensor data being refreshed at the end of each sample
- The following images are two simple block diagrams of the system with one including the optional external gas sensor:

#### BG3KE with no external sensor

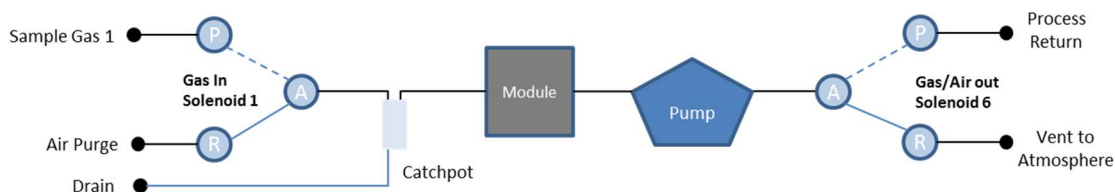

#### BG3KE with an external sensor

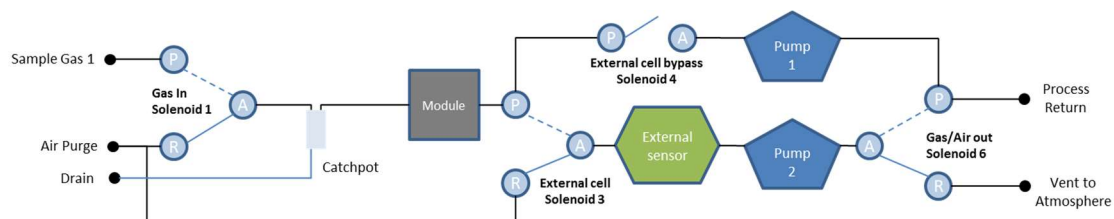



### BIOGAS 3000 INTERNAL COMPONENTS

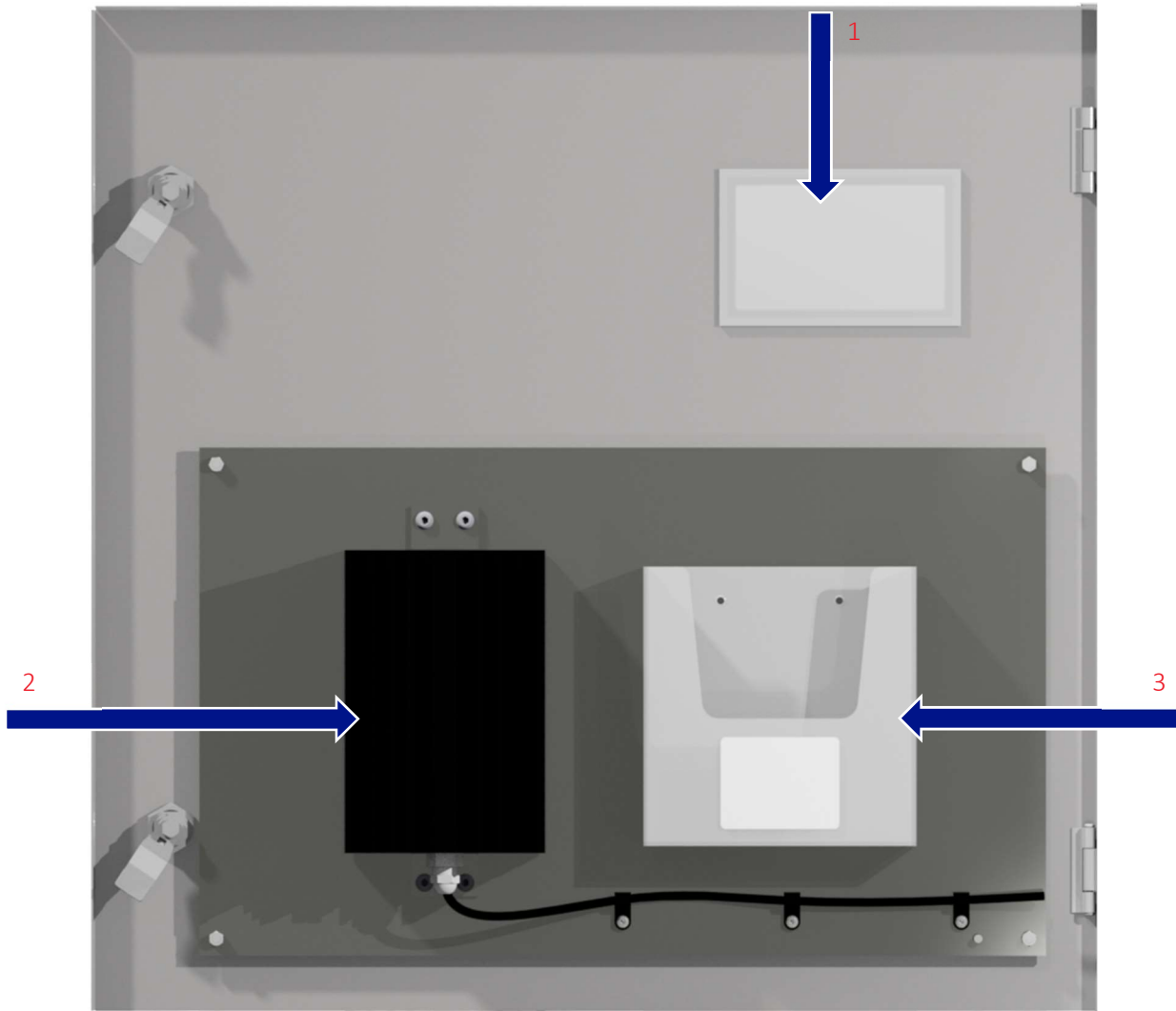

Figure 1 - BIOGAS 3000 door internals

- 1) Viewing window
- 2) Heater (110V or 230V)
- 3) Plastic wallet containing operating manual and calibration certificate

## Operating Manual

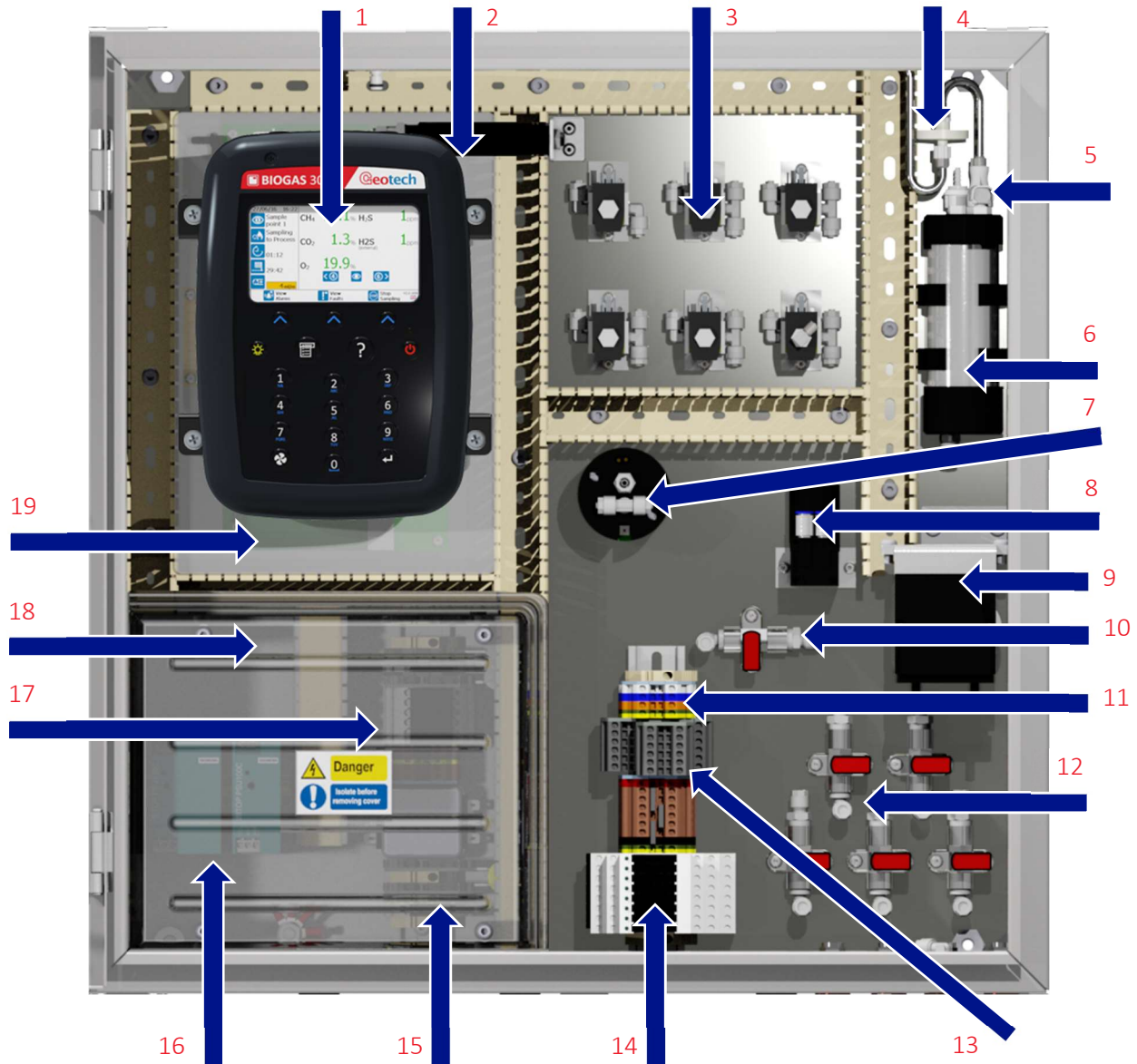

Figure 2 - BIOGAS 3000 internal components

- |                                      |                            |
|--------------------------------------|----------------------------|
| 1) BIOGAS 3000 module                | 11) Modbus terminals       |
| 2) Heater thermostat                 | 12) Gas in/out valves      |
| 3) Solenoid valves                   | 13) 4-20mA terminals       |
| 4) Inline PTFE filter                | 14) Relays                 |
| 5) Female QRC for calibration        | 15) Mains supply terminals |
| 6) Catchpot with liquid level switch | 16) Power supplies         |
| 7) External sensor                   | 17) Fuses                  |
| 8) Pumps                             | 18) Protective cover       |
| 9) Auto-drain pump (or drain valve)  | 19) Interface PCB          |
| 10) Calibration valve                |                            |

## Operating Manual

### BIOGAS 3000 MODULE FEATURES

#### Physical Characteristics of the Module

Front View:



Reference:

- 1) Display
- 2) Soft keys
- 3) Help key
- 4) On/off key
- 5) Keypad
- 6) Return key (↵)
- 7) Pump key
- 8) Backlight key
- 9) Menu key
- 10) Module mounting brackets
- 11) Rear label

Rear View:

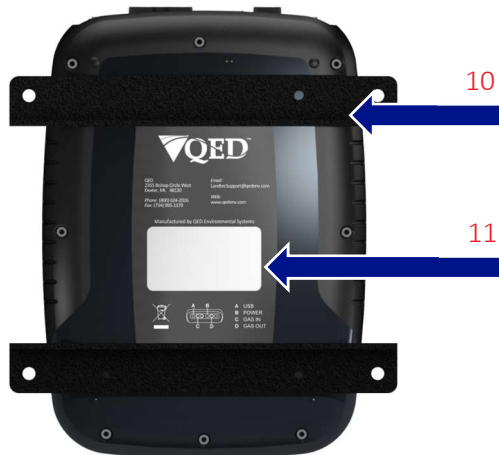

Top View:

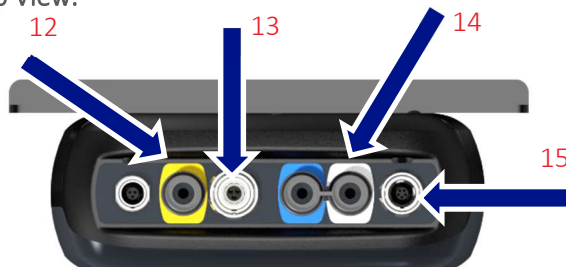

- 12) Gas outlet
- 13) Power supply connector
- 14) Gas inlet
- 15) Communications connector

Figure 3 - BIOGAS 3000 Module Features

## Operating Manual

### Definitions

#### Front View

##### Reference

16) Display

##### Definition

Shows information to the user.

17) Soft keys

The function of the three soft keys on the keypad is determined by the screen the operator is in.

18) Help key

Where '?' is shown on the display, the operator can press the help key for on-screen assistance.

19) On/off key

Press the on/off key for two seconds to switch the module on and off.

20) Keypad

Allows numeric entry from 0-9 and letters A-Z.

Keys '2', '4', '6' and '8' allow the operator to navigate 'up', 'right', 'left' and 'down' respectively in certain menu items.

Key '0' is also used as the space key when entering text.

21) Return key (↵ )

The ↵ accepts/confirms choices made by the operator for various functions and operations.

22) Pump key

Not used in normal operation but is used to aid diagnostics and assist with maintenance. It does not control the pump.

23) Backlight key

Enables the operator to turn the backlight off and on.

24) Menu key

Press the 'menu' key to navigate to the 'menu'.

#### Rear View

25) Module mounting brackets

Securely holds the module to the backplate.

26) Rear label

The serial number is the unique identification number for the BIOGAS 3000 module. The part number is the unique record for the internal configuration of the BIOGAS 3000 module at time of manufacture or last service.

## Operating Manual

### Top View

- |                              |   |
|------------------------------|---|
| 27) Gas outlet               | The gas sample exits the BIOGAS 3000 module here.         |
| 28) Power supply connector   | Power supplied from the Interface PCB connects here.      |
| 29) Gas inlet                | The gas sample enters the BIOGAS 3000 module here.        |
| 30) Communications connector | Connection point for the USB lead from the Interface PCB. |

## Operating Manual

### INSTALLATION

#### Pre-Installation Requirements

##### General

It is QED's recommendation that the installation of the BIOGAS 3000 is carried out in accordance with this operating manual and the latest edition of IEC 60079-14. Any electrical work should be carried out by a competent electrician and any relevant codes of practice should be followed.

In order to effectively install the BIOGAS 3000 system, it is important that the site is ready and in a fit state. In particular, the following points should be noted:



Power should NOT be applied before all piping and wiring has been completed and tested.

Only a qualified person should make electrical connections to the system.

- This operating manual has been read and fully understood
- A risk assessment has been performed that includes installation, operation, and maintenance of the system and the removal, where practicably possible, of any identified hazards
- Applicable codes of practice identified
- The BIOGAS 3000 system has been received on site, unpacked, packaging contents checked, and checked for obvious damage
- A suitable location is determined for the installation of the instrumentation

Note: Refer to section [Mounting the enclosure](#) for items that need to be considered.

- A suitable mains supply as detailed in this manual is installed
- All required gas lines are installed

Note: Inlet pressure to the BIOGAS 3000 system must not exceed 350 mbars (5psi). Where this is exceeded, additional pressure regulation is required.

- Output data cable has been installed (if required) to the BIOGAS 3000 location.

Note: Failure to comply with any of the above may result in additional time on site and additional costs.

#### Packaging Contents

Check the product box for the following items:

- BIOGAS 3000 system
- Key for enclosure locks
- Enclosure wall mounting brackets and fasteners

## Operating Manual

- Operating manual – found in plastic wallet on the inside of the enclosure door
- Customer wiring diagram – found in plastic wallet on the inside of the enclosure door
- Calibration certificate – found in plastic wallet on the inside of the enclosure door
- Compression fittings – found on the bulkheads on the enclosure base (see annotations 4, 5, and 7-11 on [Figure 4 - BIOGAS 3000 customer connections](#))
- Particulate filter for air purge line (QED part number 2008277/S, see section [BIOGAS 3000 Consumable Products](#)).
- Additional catchpot filter (if you purchased the hydrolysis measurement option on the BG3K3 or BG3K4)

### Storage of the System and Module

The BIOGAS 3000 system and module should not be exposed to extremes of temperature. It is the user's responsibility to ensure the system and module are kept within their ambient operating temperature range.

### Ventilation Requirements

There is an enclosure breather fitted to the BIOGAS 3000 situated at the base of the enclosure (see annotation 13 on [Figure 4 - BIOGAS 3000 customer connections](#)). It is the user's responsibility to ensure that there is a free circulation of air around the cabinet.



If the system is being installed indoors, it is QED's recommendation that a suitable gas leak detector is placed nearby to the system to inform operators of a leak before entering the room. This is not supplied by QED.

## Operating Manual

### External Customer Connections

The installation will require the operator to connect a mains cable, output cable, drain and gas pipes to the equipment.

[Figure 4 - BIOGAS 3000 customer connections](#) identifies the available connection points on the BIOGAS 3000:

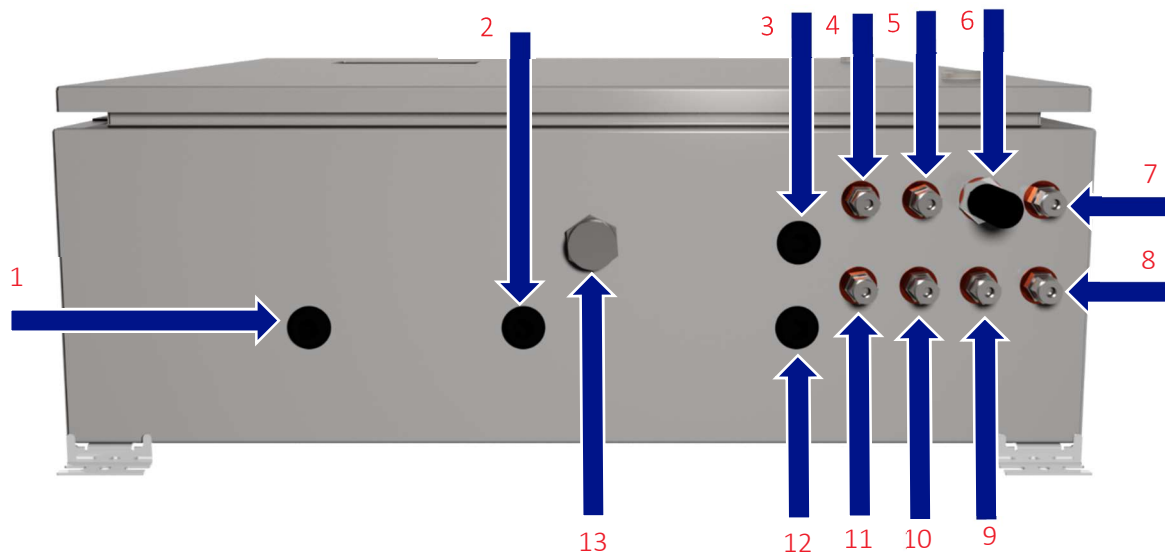

Figure 4 - BIOGAS 3000 customer connections

- |  |                                   |
|--|-----------------------------------|
| 1) Customer cable entry – mains supply | 8) Drain                          |
| 2) Customer cable entry – ethernet     | 9) Vent to Atmosphere             |
| 3) Customer cable entry – data outputs | 10) Sample Gas 4                  |
| 4) Sample Gas 1                        | 11) Sample Gas 2                  |
| 5) Sample Gas 3                        | 12) Customer cable entry – relays |
| 6) Air In                              | 13) Breather Drain                |
| 7) Process Return                      |                                   |

**Note:** There are four stopping plugs fitted to the enclosure for the customer's cable entry. An M20 stopping plug must be removed from annotations 1-3 and 12 where a cable gland is to be placed. Where a cable entry point is not being used, the M20 stopping plug must remain in place in order to maintain the IP rating of the enclosure.



The mains and output cables must enter the cabinet via a cable gland (see [Cable Gland Selection and Cord Anchorage](#)) and the mains supply should be isolated (see [Mains Wiring](#)).



## Operating Manual

### Mounting the Enclosure

The system is contained in one enclosure that is weatherproof and has a rating of IP65.

When considering the location of the equipment, the following must be considered:

- Although the enclosure is IP65, it shall be installed in a location so that it is protected against exposure to direct sunlight, precipitation and full wind pressure. For example, maintenance of the system will be made easier and safer if it is not exposed to driving rain
- Allow easy access for routine maintenance to be undertaken
- Allow easy viewing of the display through the viewing window
- Any future changes in the area, for example plantation growth causing damage to pipework
- Ensure there is no risk of damage from vehicles or animals in the area
- Avoid positioning the enclosure in direct sunlight as this may increase the internal temperature of the cabinet to outside of the operating temperature range of the equipment.

**Note:** If it is difficult to position the BIOGAS 3000 system out of direct sunlight, measures shall be taken to protect the system, such as a basic cover to provide shade.

The enclosure is to be mounted to a solid brick wall or framework (preferably stainless steel) capable of holding the weight of the system. The weight of the enclosure and contents will depend on the options that are fitted, but the maximum weight is 32kg. It is therefore recommended that the installation be undertaken by a minimum of two people.

Attach the supplied mounting brackets to each of the four corners of the enclosure using the provided fasteners, as per [Figure 5](#).



Apply a tightening torque of 8Nm.  
Failure to meet the installation requirements could make the equipment unsafe resulting in a hazard and invalidate the hazardous area certification.

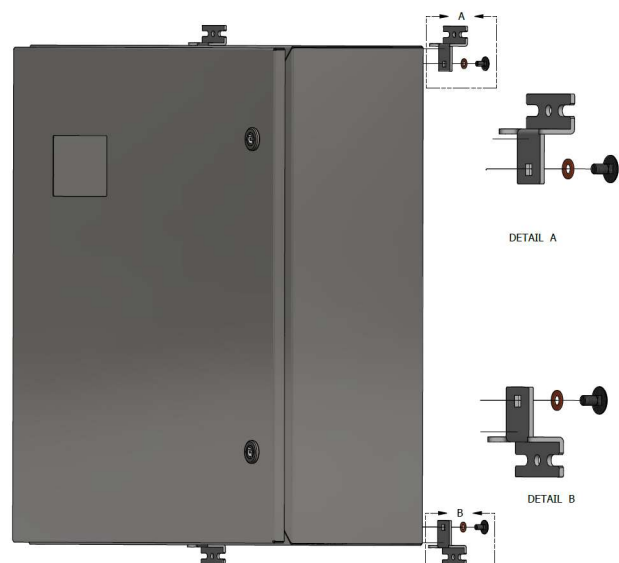

Figure 5 - Fitting the wall mounting brackets to the enclosure

## Operating Manual

Suitable nut and bolt or rawl bolt arrangements will have to be defined by the operator for fixing to the wall or framework (it is recommended that these are stainless steel). The enclosure should be mounted as square and level as possible.

Dimensions of the enclosure are provided in [Figure 6 - BIOGAS 3000 enclosure dimensions](#).

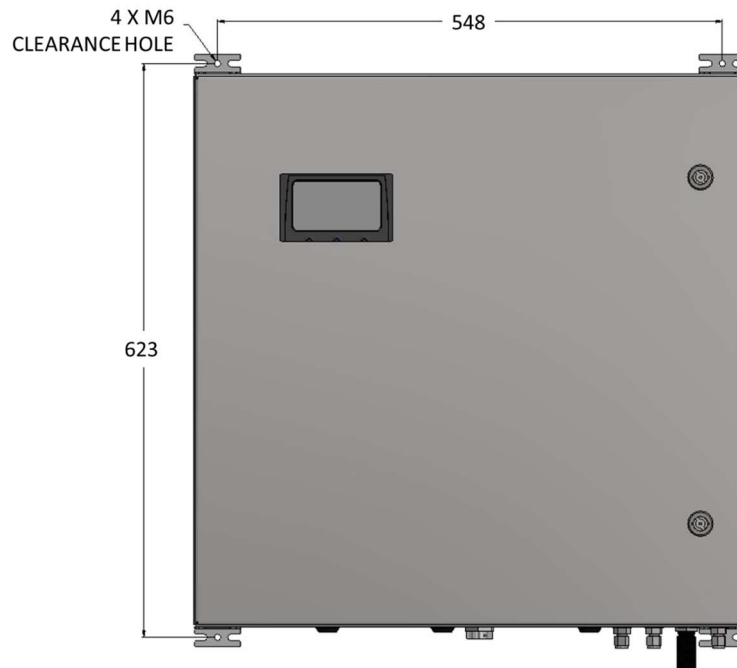

Figure 6 - BIOGAS 3000 enclosure dimensions

### Connecting the Gas Lines to the BIOGAS 3000

Note: The gas connections on the system are 6mm stainless steel bulkhead connectors with a compression fitting suitable for 6mm outer diameter tubing. It is recommended that stainless steel tubing be used where possible.

Note: After installation, ensure all tube connections are tight and free from leaks. See section [Pressure Test](#).

### Gas Sample Lines

Care should be taken in routing the sample lines, especially in cold environments. The sample lines may need insulating or even trace heating to prevent freezing of water within the pipe. This is not part of the BIOGAS 3000 system and is the responsibility of the operator.

- The sample should be taken from a suitable location at the required monitoring point. It is recommended that a valve be incorporated in the assembly so that the gas can be shut off if the sample line is removed.

## Operating Manual



*Figure 7 - Ball valve assembly*

- The line should connect to the upper surface of a horizontal pipe or on a vertical standing pipe. This will prevent excessive amounts of water entering the sample line.
- An additional ball valve should be incorporated in to each sample line close to the BIOGAS 3000 system. This ball valve will be used to isolate the gas supply to the system as part of pressure testing the system during routine maintenance.
- The supplied catchpot filter should be fitted to the sample gas 1 line (external to the cabinet) if you purchased the hydrolysis measurement option on the BG3K3 or BG3K4.
- The sample tube should be connected to the bulkhead connectors labelled 'SAMPLE GAS 1', 'SAMPLE GAS 2', 'SAMPLE GAS 3', and 'SAMPLE GAS 4' where applicable – see annotations 4, 5, 10, and 11 on [Figure 4 - BIOGAS 3000 customer connections](#).

**Note:** The maximum distance the BIOGAS 3000 can be from the sample point is 50 meters.

### Process Return

This is the line where measured gas from the system is exhausted. It can be returned to the process or vented to atmosphere.

Care should be taken in routing the process return line, especially in cold environments. The process return line may need insulating or even trace heating to prevent freezing of water within the pipe.

This is not part of the BIOGAS 3000 system and is the responsibility of the operator.

- The gas exhaust line should be returned to a suitable location at the required point. It is recommended that a valve be incorporated in the assembly so that the gas can be shut off if the sample line is removed. See [Figure 7 - Ball valve assembly](#).

## Operating Manual



The gas being exhausted at this point of the system will be flowing at approximately 300ml/min. If the sample gas is being vented to atmosphere, it should be routed to a safe and well-ventilated area.

- An additional ball valve should be incorporated in to the piping close to the BIOGAS 3000 system, even when being vented to atmosphere. This ball valve will be used as part of pressure testing the system during routine maintenance.
- The gas exhaust line should be connected to the bulkhead connector labelled 'PROCESS RETURN' – see annotation 7 on [Figure 4 - BIOGAS 3000 customer connections](#).



The gas being exhausted at this point of the system will be flowing at approximately 300ml/min. If the sample gas is being vented to atmosphere, it should be routed to a safe and well-ventilated area.

- The process return line should ideally be within  $\pm 30$ mbar of standard atmospheric pressure, and must always be lower than the sample gas inlet pressure to avoid system damage.

### Air In

The air purge inlet requires uncontaminated air for the purge line. If uncontaminated air is available, the particulate filter should remain in place.

If uncontaminated air cannot be guaranteed at the location of the analyser, the particulate filter should be removed and a pipe should be connected in its place and terminated at a point where uncontaminated air is present. The sample tube should be connected to the bulkhead connector labelled 'AIR IN' – see annotations 6 on [Figure 4 - BIOGAS 3000 customer connections](#).

### Vent to Atmosphere



When performing an air purge the gas that was previously sampled will be vented to atmosphere for a short period, typically 10 seconds. This equates to approximately 50ml of gas per air purge. In addition, when performing a user calibration, the calibration gas will be exhausted from this bulkhead. It is therefore recommended that the 'Vent to Atmosphere' line should be routed to a safe and well-ventilated area.

- A ball valve should be incorporated in to the piping close to the BIOGAS 3000 system. This ball valve will be used as part of pressure testing the system during routine maintenance.
- The sample tube should be connected to the bulkhead connector labelled 'VENT TO ATMOSPHERE' – see annotation 9 on [Figure 4 - BIOGAS 3000 customer connections](#).

### Drain

The system incorporates a catchpot and drain for removal of liquid to help prevent water from entering the system (see annotation 6 on [Figure 2 - BIOGAS 3000 internal components](#)). However,

## Operating Manual

additional water filtering may be required where the sample is heavily contaminated with water (available from QED, see part number GA3KP.S15 in section [BIOGAS 3000 Consumable Products](#)).

Care should be taken in routing the drain line, especially in cold environments. The drain line may need insulating or even trace heating to prevent freezing of water within the pipe. This is not part of the BIOGAS 3000 system and is the responsibility of the operator.

Alternatively, the contents can be emptied into a suitable container and disposed of in a safe manner.

If the auto-drain option is fitted, no manual draining of the system is required.

- The drain line should be connected to the bulkhead connector labelled 'DRAIN' – see annotation 8 on [Figure 4 - BIOGAS 3000 customer connections](#).
- The drain line should be run to a position where it is safe to discharge the small amount of liquid that is removed from the sample gas.
- The contents of the catchpot are drained under gravity. Therefore, any tubing needs to be lower than the drain compression fitting.
- The drain connection on the system is a 6mm stainless steel bulkhead connector with a compression fitting suitable for 6mm outer diameter tubing. It is recommended that stainless steel tubing be used where possible.
- The catchpot contains a liquid level (reed) switch. When the liquid reaches a certain level, the switch activates and informs the BIOGAS 3000 module. From here, an icon is displayed on screen and if configured triggers a relay (see [Configure Relays](#)).
- Refer to the [Emptying the Catchpot](#) section of this operating manual for how to drain the catchpot.
- When taking a gas sample, ensure the drain ball valve (see annotation 9 on [Figure 2 - BIOGAS 3000 internal components](#)) is in the closed (horizontal) position.

**Note: If the auto-drain option is fitted, there will be no drain valve fitted to the equipment.**

For the hydrolysis tank option chosen at manufacture, additional filtration will be required on sample point 1, as this does not pass through the system's catchpot. See QED part number GA3KP.S15 in section [BIOGAS 3000 Consumable Products](#).



The catchpot can hold approximately 90ml of liquid. Dependent upon the application the liquid removed may be contaminated and should be discharged to an area where it is safe to do so.

This line may also vent sample gas for a brief period during each draining operation if the sample inlet and gas out valves are not closed.

## Operating Manual

### Protective Cover

The BIOGAS 3000 has a protective cover fitted inside the main enclosure to cover areas where mains voltages are present. This cover must be removed in order to wire the mains supply to the BIOGAS 3000 system and to replace fuses.



The cover must only be removed when power to the system has been isolated. Failure to isolate the power before removing the cover could result in an electric shock.

It is vital that after installation and prior to powering the equipment that the protective cover is replaced. Failure to replace the cover could result in an electric shock.

The cover is removed by unscrewing four M4 x 12mm button head screws with a 4mm hexagon tool (see [Figure 8 - Mains cover removal](#)). The cover and screws must be kept safe once removed to ensure that they are not lost and can be refitted once installation is complete.

To fit the cover, simply align the holes in the protective cover with the four pillars fixed to the BIOGAS 3000 back plate and screw in to place using the 4mm hexagon tool.

**Note:** For clarity, some images of the BIOGAS 3000 system in this operating manual may not include the protective cover.

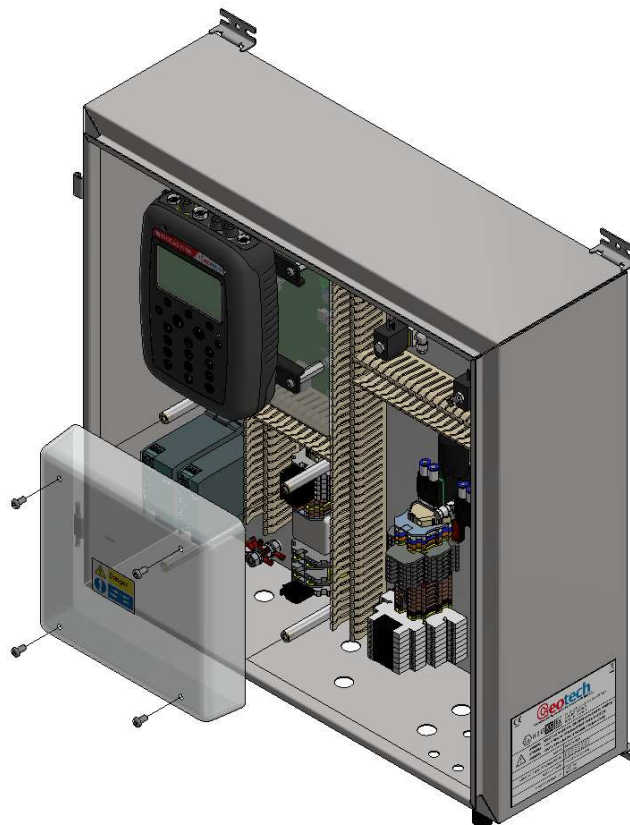

Figure 8 - Mains cover removal

## Operating Manual

### Cable Gland Selection and Cord Anchorage

To maintain the integrity and certification of the equipment a cable gland must be selected that:

- is suitably certified – see section [Marking](#) in this operating manual for the equipment marking
- has a minimum rating of IP65
- shall be protected against abrasion and sharp bends at the point where the cord enters the equipment, by an inlet or bushing with a smoothly rounded opening
- has been fitted and tightened to the recommended torque set by the manufacturer.

In addition, the cable gland must have a means of anchoring the cable. The cord anchorage shall relieve the conductors of the cord from strain, including twisting, where they are connected within the equipment, and shall protect the insulation of the conductors from abrasion. The protective earth conductor shall be last to take the strain if the cord slips in its anchorage.

Cord anchorages shall meet the following requirements:

- The cord shall not be clamped by a screw that bears directly on the cord
- Knots in the cord shall not be used
- It shall not be possible to push the cord into the equipment to an extent that could cause a hazard
- Failure of the cord insulation in a cord anchorage that has metal parts shall not cause accessible conductive parts to become hazardous live
- It shall not be possible to loosen the cord anchorage without the use of a tool
- It shall be designed so that cord replacement does not cause a hazard, and it shall be clear how the relief from strain is provided.



A compression bushing shall not be used as cord anchorage.

Failure to meet the above requirements could make the equipment unsafe resulting in a hazard and invalidate the hazardous area certification.

## Operating Manual

### Cable Conductor Sizes and Insulation Requirements

#### Cable Conductor Sizes

Cable conductors must meet the following requirements, be suitable for the environment, and distance to the supply:

Function	Type	Conductor Size	Voltage Rating	Current Rating
Mains supply	Tri-rated	0.14 – 4.0mm <sup>2</sup> solid	230Vac	3.15A
4-20mA outputs	Twisted pair	0.14 – 2.5mm <sup>2</sup> stranded	24Vdc	20mA
Modbus outputs	Twisted pair	0.14 – 4.0mm <sup>2</sup> solid	12Vdc	83.3mA
Relays	Tri-rated	0.14 – 2.5mm <sup>2</sup> stranded	24Vdc	6A
Ethernet	Cat6 (min.)	As per IEEE 802.3u specification. Shall have cable shielding.		

Use Copper conductors only for field-wiring terminals.



Failure to meet the above requirements could make the equipment unsafe resulting in a hazard and invalidate the hazardous area certification.

#### Cable Insulation Requirements

In addition to the table below, the cable insulation must comply with a recognised standard and have a flammability rating of V1 or better:

Function	Cable Insulation thickness (min)	Insulation temperature rating (min)
Mains supply	0.6mm	75°C / 167°F
4-20mA outputs	0.2mm	
Modbus outputs	0.2mm	
Relays	0.2mm	
Ethernet	0.2mm	



Failure to meet the above requirements could make the equipment unsafe resulting in a hazard and invalidate the hazardous area certification.

### Mains Wiring

#### Protective Earthing and Mains Supply

The safety of the equipment depends on it being effectively earthed via the mains supply.

The mains requirement for the system can be found on the side of the enclosure and is shown on [Figure 9 - BIOGAS 3000 electrical label](#):



## Operating Manual

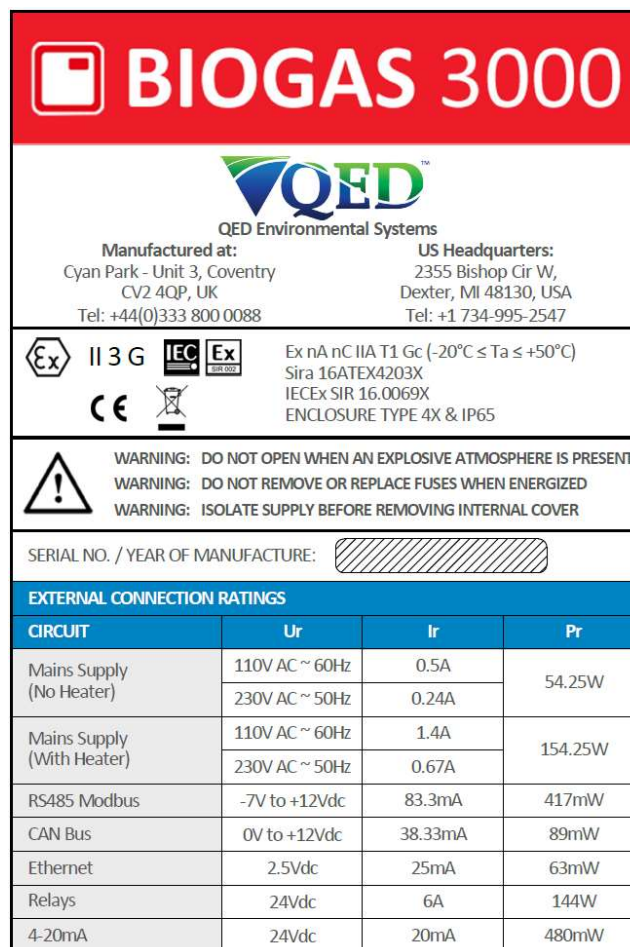

Figure 9 - BIOGAS 3000 electrical label

The mains fuse rating (FS1) of the equipment is 3.15A.

The equipment must be provided with a double-pole switched and fused mains supply. The switch must be mounted as close to the equipment as practicably possible so that it can be easily reached and clearly identified as the disconnecting device for the system.

The mains cable must be three core cable (live, neutral and earth) and enter the enclosure via a cable gland (see [Cable Gland Selection and Cord Anchorage](#)) through the mains supply customer cable entry point (see annotation 1 on [Figure 4 - BIOGAS 3000 customer connections](#)).

### How to Wire the Mains Supply

Only a qualified person should make electrical connections to the system.



Ensure the power is isolated before removing the [Protective Cover](#) to wire the system.

Failure to connect a suitable earth to the system could result in serious injury.

The equipment must be provided with a double-pole switched and fused mains supply.

The switch must be mounted as close to the equipment as practicably possible and

## Operating Manual

clearly identified as the disconnecting device for the system.

Cable glands should meet the requirements of [Cable Gland Selection and Cord Anchorage](#). Cable insulation and conductor sizes must meet the requirements of [Cable Conductor Sizes and Insulation Requirements](#).

If using armoured cable, the armour must not be used as the main earth connection for the BIOGAS 3000. If earthing of the armour is required, this must not be taken from the BIOGAS 3000.

All cables should be crimped with an appropriate insulated ferrule for the size of the cable being used. In addition, the cable insulation must be housed adequately within the protective sheath of the ferrule.

Terminals that are wired should be tightened to a minimum of 0.6 N·m. Failure to tighten to this requirement could make the equipment unsafe resulting in a hazard and invalidate the hazardous area certification.

The protective cover must be replaced after wiring and before power is applied.

Refer to annotation 15 on [Figure 2 - BIOGAS 3000 internal components](#) for the location of the mains wiring terminals, and [Wiring Diagram 1 – Mains](#) for how to wire the mains cable to the BIOGAS 3000 system. A label within the system identifies the appropriate inputs live (L), earth (E), and neutral (N).

Note: For cable conductor sizes and cable insulation requirements, please refer to section [Cable Conductor Sizes and Insulation Requirements](#).

## Operating Manual

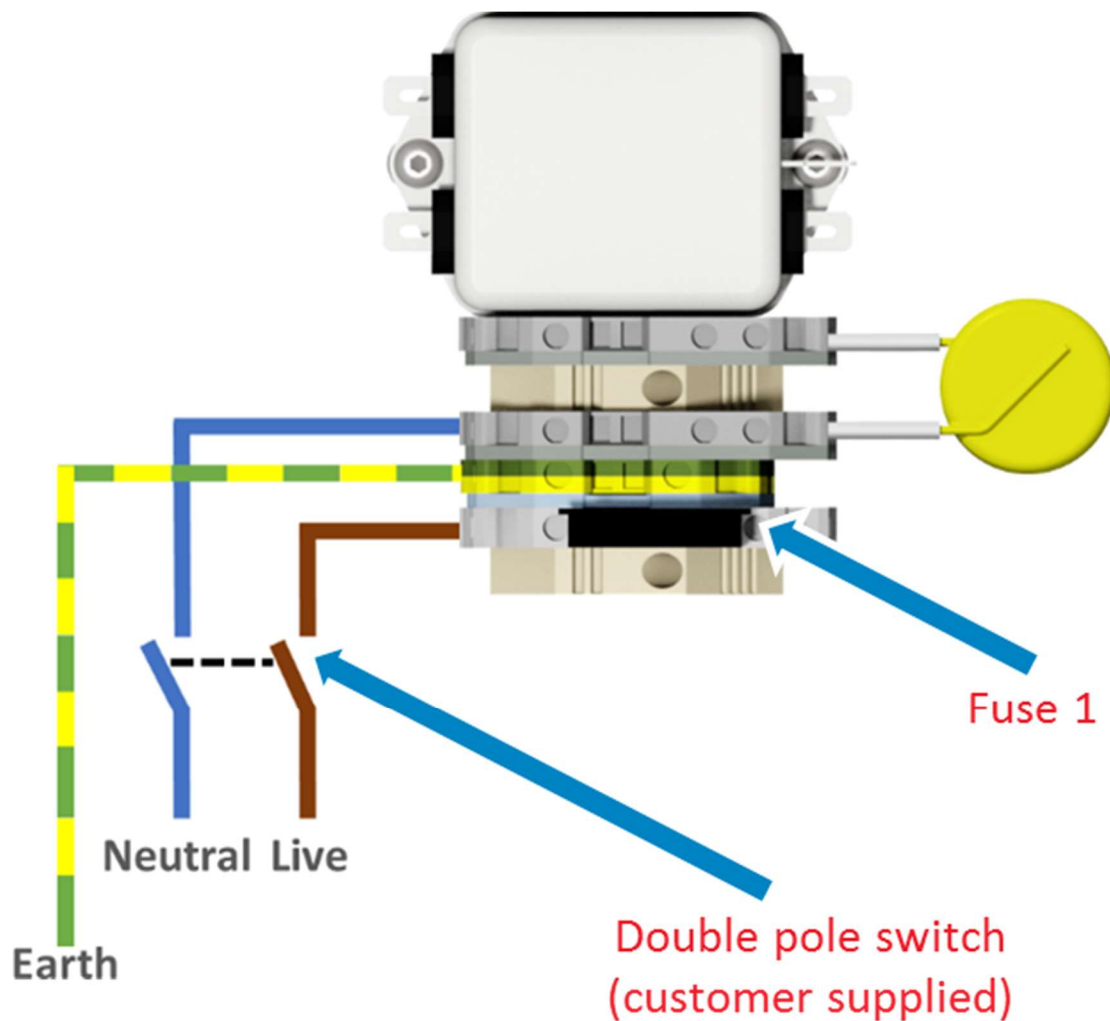

Wiring Diagram 1 – Mains

### Modbus Digital Output

If Modbus digital outputs are being used, the cable must enter the enclosure via a suitably rated cable gland (see [Cable Gland Selection and Cord Anchorage](#)) and cable (see [Cable Conductor Sizes and Insulation Requirements](#)), through the data outputs customer cable entry point (see annotation 3 on [Figure 4 - BIOGAS 3000 customer connections](#)).

A label within the system identifies the appropriate outputs '+', '-', and 'LG'. Refer to annotation 10 on [Figure 2 - BIOGAS 3000 internal components](#) for the Modbus terminal connections.



The BIOGAS 3000 Modbus terminals must only be used for standard Modbus communications. No other connections must be made as they could make the equipment unsafe resulting in a hazard and invalidate the hazardous area certification.

## Operating Manual

## Wiring the BIOGAS 3000 Modbus Outputs

Only a qualified person should make electrical connections to the system.

Ensure the power is isolated.

Cable glands should meet the requirements of [Cable Conductor Sizes and Insulation Requirements](#).

Cable insulation and conductor sizes must meet the requirements of [Cable Conductor Sizes and Insulation Requirements](#).

If using armoured cable, the armour must not be used as the main earth connection for the BIOGAS 3000. If earthing of the armour is required, this must not be taken from the BIOGAS 3000.



All cables should be crimped with an appropriate insulated ferrule for the size of the cable being used. In addition, the cable insulation must be housed adequately within the protective sheath of the ferrule.

Terminals that are wired or unused should be tightened to a minimum of 0.6 N·m. Failure to tighten to this requirement could make the equipment unsafe resulting in a hazard and invalidate the hazardous area certification.

The input voltage range to the BIOGAS 3000 Modbus terminals must not exceed -7 to +12V and the current must not exceed 83.3mA. Operating outside of this range will invalidate the hazardous area certification.

Wire the outputs in accordance with [Wiring Diagram 2 – Modbus](#). For optimum performance, it is recommended that screened twisted pair cable be used.

Note: For cable conductor sizes and cable insulation requirements, please refer to section [Cable Conductor Sizes and Insulation Requirements](#).

## Operating Manual

When wiring the outputs, the twisted pairs must be as follows:

Terminal Colour	Wiring Information	Pair
Orange	Signal A (RS485) '+'	Pair one
Blue	Signal B (RS485) '-'	
White	Logic Ground (0V) 'LG'	Pair two

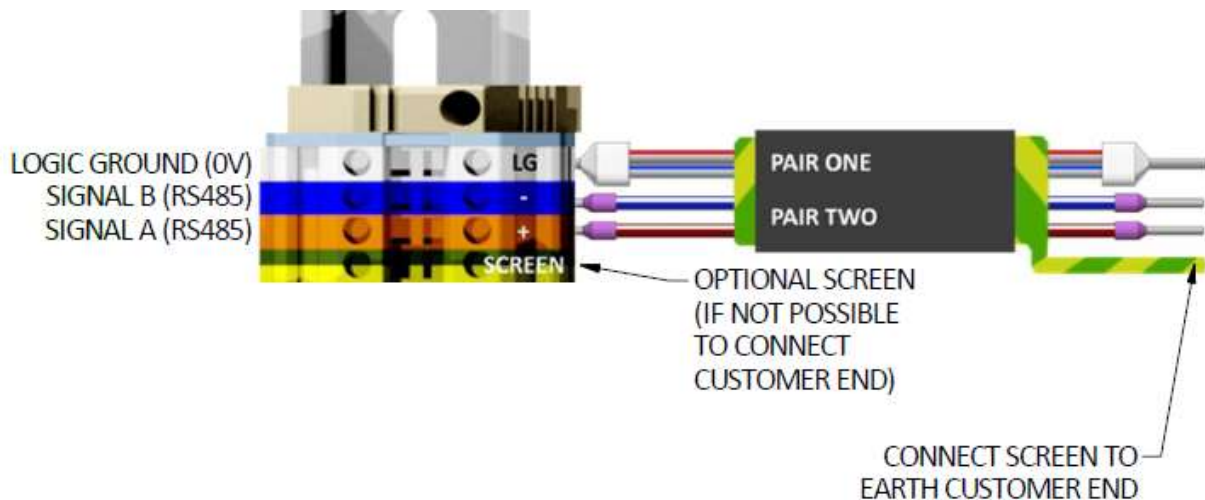

Wiring Diagram 2 – Modbus

### Default Configuration of the BIOGAS 3000 Modbus Port

The BIOGAS 3000 Modbus port has a default configuration of the following:

Node Address	1
Baud Rate	19200
Parity	Even
Stop Bits	1
Termination	Off
The BIOGAS 3000 acts as a slave.	
The protocol is MODBUS RTU.	

Note: A termination resistor of 200 ohms is fitted internally between the positive and negative Modbus signals of the BIOGAS 3000, which must be the last connection on the 'bus'. The termination resistor can be turned 'On' or 'Off' via the menu on the BIOGAS 3000 module (see [Configure Modbus Slave](#)). Similarly, the master device on the 'bus' should have a termination resistor.

The node address, baud rate, parity, and termination are all configurable settings found within the menu of the BIOGAS 3000 module; see section [Configure Modbus Slave](#).

## Operating Manual

### Readable Parameters of the BIOGAS 3000

Below is a table of addresses that can be read from the BIOGAS 3000.

#### Read-Only Single Bit Registers

Register Address		Parameter	Content information
(Dec)	(Hex)		
0	0000h	System status	0 – system OK 1 – system fault
1	0001h	Flow status	0 – flow OK 1 – flow fail
2	0010h	Communications status	0 – communications OK 1 – communications error
3	0011h	Catchpot status	0 – catchpot empty 1 – catchpot full

#### Read-Only 16-Bit Registers

Register Address		Parameter	Content Information
(Dec)	(Hex)		
0	0000h	Run status	0 – running process 1 – running with non-critical fault 2 – stopped by user (outputs frozen) 3 – stopped by user (fixed at safe values) 4 – stopped with critical fault (outputs frozen)
32	0020h	Time and date: year	e.g. 2016
33	0021h	Time and date: Month	1-12
34	0022h	Time and date: day	1-31
35	0023h	Time and date: hour	0-23
36	0024h	Time and date: minute	0-59
37	0025h	Time and date: second	0-59
48	0030h	Current sample point	0 – Idle 1-4 – Sampling from SPn 65535 – Purge 257 – Main and External Cell (EC) Sampling 65281 – Main Sampling, EC Purging 44034 – AutoCal Sampling Bottle 44287 – AutoCal Purging
128	0080h	Service due: year	e.g. 2016

## Operating Manual

129	0081h	Service due: month	1-12
130	0082h	Service due: day	1-31
512	0200h	Alarm 1 Status	0 – No alarm 1 – Triggered 2 – Triggered and in recovering zone 4 – Latched 8 – Muted 9 – Triggered alarm and muted 10 – Recovering alarm and muted 12 – Latched and muted
513 to 519	0201h to 0207h	Alarm 2 to alarm 7 Status	Repeated as per alarm 1
768	0300h	Sample point 1 last reading: year	e.g. 2016
769	0301h	Sample point 1 last reading: month	1-12
770	0302h	Sample point 1 last reading: day	1-31
771	0303h	Sample point 1 last reading: hour	0-23
772	0304h	Sample point 1 last reading: minute	0-59
773	0305h	Sample point 1 last reading: second	0-59
1024 to 1029	0400h to 0405h	Sample point 2 last reading time and date	Repeated as per sample point 1
1280 to 1285	0500h to 0505h	Sample point 3 last reading time and date	Repeated as per sample point 1
1536 to 1541	0600h to 0605h	Sample point 4 last reading time and date	Repeated as per sample point 1
800	0320h	SP1 Status: CH <sub>4</sub>	0 – Ok 1 – Overrange 2 – Underrange 3 – Error 5 – Calibration Required
801	0321h	SP1 Status: CO <sub>2</sub>	0 – Ok

## Operating Manual

			<ul style="list-style-type: none"> <li>1 – Overrange</li> <li>2 – Underrange</li> <li>3 – Error</li> </ul>
802	0322h	SP1 Status: O <sub>2</sub>	Repeated as per SP1 Status:CO <sub>2</sub>
803	0323h	SP1 Status: Internal cell	Repeated as per SP1 Status:CO <sub>2</sub>
805	0325h	SP1 Status: External cell	Repeated as per SP1 Status:CO <sub>2</sub>
807	0327h	SP1 Status: Baro	Repeated as per SP1 Status:CO <sub>2</sub>
809	0329h	SP1 Status: Flow	Repeated as per SP1 Status:CO <sub>2</sub>
1056 to 1065	0420h to 0429h	SP2 Status	Repeated as per SP1 Status
1312 to 1321	0520h to 0529h	SP3 Status	Repeated as per SP1 Status
1568 to 1577	0620h to 0629h	SP4 Status	Repeated as per SP1 Status
832	0340h	Last reading sample point 1: CH <sub>4</sub>	CH <sub>4</sub> reading x 10 e.g. 61.1% would be 611
833	0341h	Last reading sample point 1: CO <sub>2</sub>	CO <sub>2</sub> reading x 10 e.g. 38.7% would be 387
834	0342h	Last reading sample point 1: O <sub>2</sub>	O <sub>2</sub> reading x 10 e.g. 0.5% would be 5
835	0343h	Last reading sample point 1: Internal cell	Internal cell reading e.g. 3500
837	0345h	Last reading sample point 1: External cell	External cell reading e.g. 3500
839	0347h	Last reading sample point 1: Baro	Baro reading e.g. 1025
841	0349h	Last reading sample point 1: Flow	Pump flow reading e.g. 275
1088	0440h	Last reading sample point 2: CH <sub>4</sub>	CH <sub>4</sub> reading x 10 e.g. 61.1% would be 611
1089	0441h	Last reading sample point 2: CO <sub>2</sub>	CO <sub>2</sub> reading x 10 e.g. 38.7% would be 387
1090	0442h	Last reading sample point 2: O <sub>2</sub>	O <sub>2</sub> reading x 10 e.g. 0.5% would be 5



## Operating Manual

1091	0443h	Last reading sample point 2: Internal cell	Internal cell reading e.g. 3500
1093	0445h	Last reading sample point 2: External cell	External cell reading e.g. 3500
1095	0447h	Last reading sample point 2: Baro	Baro reading e.g. 1025
1097	0449h	Last reading sample point 2: Flow	Pump flow reading e.g. 275
1344	0540h	Last reading sample point 3: CH <sub>4</sub>	CH <sub>4</sub> reading x 10 e.g. 61.1% would be 611
1345	0541h	Last reading sample point 3: CO <sub>2</sub>	CO <sub>2</sub> reading x 10 e.g. 38.7% would be 387
1346	0542h	Last reading sample point 3: O <sub>2</sub>	O <sub>2</sub> reading x 10 e.g. 0.5% would be 5
1347	0543h	Last reading sample point 3: Internal cell	Internal cell reading e.g. 3500
1349	0545h	Last reading sample point 3: External cell	External cell reading e.g. 3500
1351	0547h	Last reading sample point 3: Baro	Baro reading e.g. 1025
1353	0549h	Last reading sample point 3: Flow	Pump flow reading e.g. 275
1600	0640h	Last reading sample point 4: CH <sub>4</sub>	CH <sub>4</sub> reading x 10 e.g. 61.1% would be 611
1601	0641h	Last reading sample point 4: CO <sub>2</sub>	CO <sub>2</sub> reading x 10 e.g. 38.7% would be 387
1602	0642h	Last reading sample point 4: O <sub>2</sub>	O <sub>2</sub> reading x 10 e.g. 0.5% would be 5
1603	0643h	Last reading sample point 4: Internal cell	Internal cell reading e.g. 3500
1605	0645h	Last reading sample point 4: External cell	External cell reading e.g. 3500
1607	0647h	Last reading sample point 4: Baro	Baro reading e.g. 1025
1609	0649h	Last reading sample point 4: Flow	Pump flow reading e.g. 275

## Operating Manual

### Read-Only 32-Bit Registers

Readings stored in two 16-bit read-only registers as a single precision real/floating point number:

Register Address		Parameter	Content Information
(Dec)	(Hex)		
33024	8100h	Last reading sample point 1: CH <sub>4</sub>	CH <sub>4</sub> reading e.g. 61.1
33026	8102h	Last reading sample point 1: CO <sub>2</sub>	CO <sub>2</sub> reading e.g. 38.7
33028	8104h	Last reading sample point 1: O <sub>2</sub>	O <sub>2</sub> reading e.g. 0.5
33030	8106h	Last reading sample point 1: Internal cell	Internal cell reading e.g. 3500
33034	810Ah	Last reading sample point 1: External cell	External cell reading e.g. 3500
33038	810Eh	Last reading sample point 1: Baro	Baro reading e.g. 1025
33042	8112h	Last reading sample point 1: Flow	Pump flow reading e.g. 275
33280	8200h	Last reading sample point 2: CH <sub>4</sub>	CH <sub>4</sub> reading e.g. 61.1
33282	8202h	Last reading sample point 2: CO <sub>2</sub>	CO <sub>2</sub> reading e.g. 38.7
33284	8204h	Last reading sample point 2: O <sub>2</sub>	O <sub>2</sub> reading e.g. 0.5
33286	8206h	Last reading sample point 2: Internal cell	Internal cell reading e.g. 3500
33290	820Ah	Last reading sample point 2: External cell	External cell reading e.g. 3500
33294	820Eh	Last reading sample point 2: Baro	Baro reading e.g. 1025
33298	8212h	Last reading sample point 2: Flow	Pump flow reading e.g. 275
33536	8300h	Last reading sample point 3: CH <sub>4</sub>	CH <sub>4</sub> reading e.g. 61.1

## Operating Manual

33538	8302h	Last reading sample point 3: CO <sub>2</sub>	CO <sub>2</sub> reading e.g. 38.7
33540	8304h	Last reading sample point 3: O <sub>2</sub>	O <sub>2</sub> reading e.g. 0.5
33542	8306h	Last reading sample point 3: Internal cell	Internal cell reading e.g. 3500
33546	830Ah	Last reading sample point 3: External cell	External cell reading e.g. 3500
33550	830Eh	Last reading sample point 3: Baro	Baro reading e.g. 1025
33554	8312h	Last reading sample point 3: Flow	Pump flow reading e.g. 275
33792	8400h	Last reading sample point 4: CH <sub>4</sub>	CH <sub>4</sub> reading e.g. 61.1
33794	8402h	Last reading sample point 4: CO <sub>2</sub>	CO <sub>2</sub> reading e.g. 38.7
33796	8404h	Last reading sample point 4: O <sub>2</sub>	O <sub>2</sub> reading e.g. 0.5
33798	8406h	Last reading sample point 4: Internal cell	Internal cell reading e.g. 3500
33802	840Ah	Last reading sample point 4: External cell	External cell reading e.g. 3500
33806	840Eh	Last reading sample point 4: Baro	Baro reading e.g. 1025
33810	8412h	Last reading sample point 4: Flow	Pump flow reading e.g. 275

**Note:** Floating-point numbers consist of two 16-bit words to give a 32-bit single precision floating point number. The first word (e.g. 33802) holds the sign in bit 15, the exponent in bits 14-7, part of the mantissa in bits 6-0. The remaining part of the mantissa is in the next register (e.g. 33803) bits 15 – 0.

### 4-20mA Outputs

If analogue outputs are being used, the cable must enter the enclosure via a suitably rated cable gland (see [Cable Gland Selection and Cord Anchorage](#)) and cable (see [Cable Conductor Sizes and Insulation Requirements](#)), through the data outputs customer cable entry point (see annotation 3 on [Figure 4 - BIOGAS 3000 customer connections](#)).

## Operating Manual

The outputs on the BIOGAS 3000 power the loop (24V) to allow the customers system to sink it to ground (0V).

Relays within the equipment can be used to indicate the status of the 4-20mA channel. Refer to section [Configure Relays](#) for more information.

**Note:** There are various combinations of configuring the system and this operating manual will describe the most common method. If your system does not support this, please contact your local distributor, or our technical support team at QED on +44(0)333 800 0088 or email [technical@qedenv.co.uk](mailto:technical@qedenv.co.uk).

### General Information

There are two sets of terminals for the 4-20mA signals. One set is a bank of terminals that provide a common 0V or 24V. The other group are double-deck terminals that provide the analogue signal depending on the configuration of the common terminal.

For the common terminals, labels identify the appropriate terminals namely from left to right ('0V', 'T1' through 'T6', '24V'). 'T1' to 'T6' are commoned together using a 3-way bridge connector between either the '0V' or the '24V' terminal.

For the analogue channels, labels identify the appropriate terminal on the double-deck namely:

- Top deck: 'CH1A' through 'CH6A'
- Bottom deck: 'CH1B' through 'CH6B'

Refer to annotation 13 in [Figure 2 - BIOGAS 3000 internal components](#) for the terminal location and [Wiring Diagram 3 - 4-20mA circuit](#) for the 4-20mA terminal identification.

## Operating Manual

### Wiring the BIOGAS 3000 to a Current Sinking Input

For this method, the power to the loop is provided by the BIOGAS 3000. The BIOGAS 3000 sources the current.

Only a qualified person should make electrical connections to the system.

Ensure the power is isolated.

Cable glands should meet the requirements of [Cable Gland Selection and Cord Anchorage](#).

Cable insulation and conductor sizes must meet the requirements of [Cable Conductor Sizes and Insulation Requirements](#).



If using armoured cable, the armour must not be used as the main earth connection for the BIOGAS 3000. If earthing of the armour is required, this must not be taken from the BIOGAS 3000.

All cables should be crimped with an appropriate insulated ferrule for the size of the cable being used. In addition, the cable insulation must be housed adequately within the protective sheath of the ferrule.

Terminals that are wired or unused should be tightened to a minimum of 0.6 N.m. Failure to tighten to this requirement could make the equipment unsafe resulting in a hazard and invalidate the hazardous area certification.

Wire the outputs in accordance with [Wiring Diagram 3 - 4-20mA circuit \(current sink\)](#). For optimum performance, it is recommended that screened twisted pair cable be used.

Note: For cable conductor sizes and cable insulation requirements, please refer to section [Cable Conductor Sizes and Insulation Requirements](#).

## Operating Manual

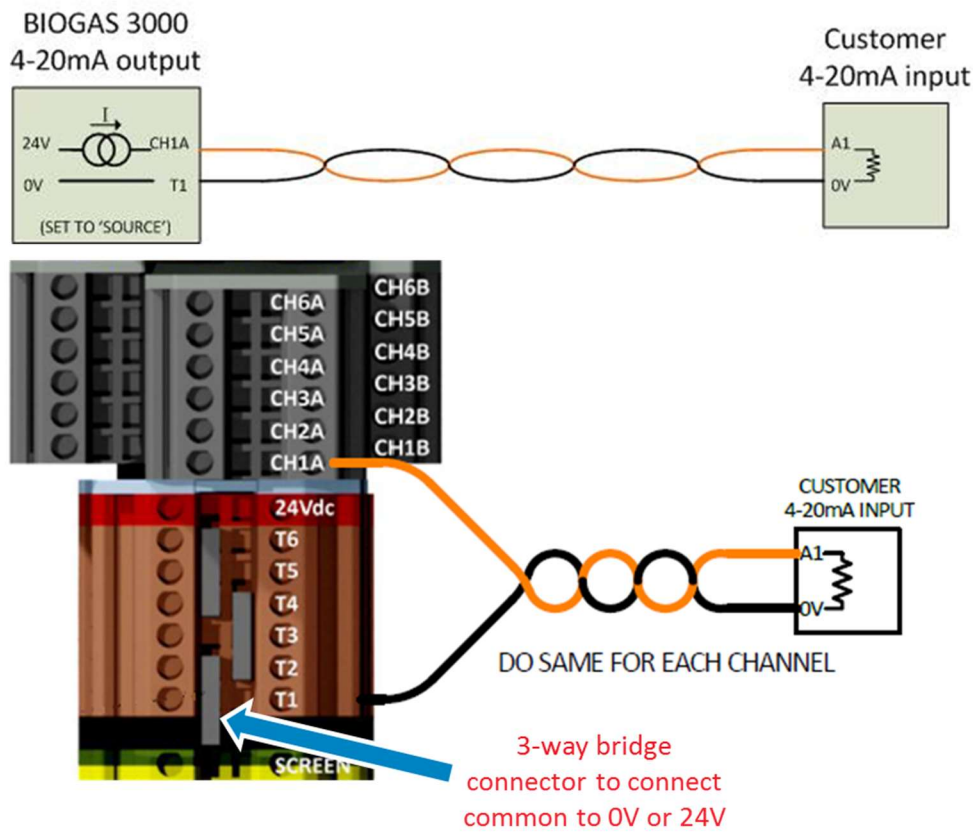

Wiring Diagram 3 - 4-20mA circuit

Note: For wiring into a current source system, please contact your local distributor, or our technical support team at QED on +44(0)333 800 0088 or email [technical@qedenv.co.uk](mailto:technical@qedenv.co.uk).

### 4-20mA Scaling

The following table details the scaling on the 4-20mA channels:

Gas	4 mA reading	20 mA reading
CH4	0.0%	100.0%
CO2	0.0%	100.0%
O2	0.0%	25.0%
H2S 0-50ppm	0ppm	50ppm
H2S 0-200ppm	0ppm	200ppm
H2S 0-500ppm	0ppm	500ppm
H2S 0-1,000ppm	0ppm	1,000ppm
H2S 0-5,000ppm	0ppm	5,000ppm
H2S 0-10,000ppm	0ppm	10,000ppm
H2S 0-40,000ppm	0ppm	39,999ppm
H2 0-1,000ppm	0ppm	1,000ppm
CO 0-1,000ppm	0ppm	1,000ppm

## Operating Manual

In the event of a fault condition on the channel or the channel reading outside its normal range, the 4-20mA output will be as follows:

Fault Condition	4-20mA reading	Gas Readings Screen display
Error	2.5 mA	****
Under range	3.0 mA	<<<<
Over range	3.8 mA	>>>>

### Relays

**Note:** The relays are configurable for alarm notifications, sample point monitoring notifications, air purge notifications, catchpot full notifications, and 4-20mA signal notifications. The configuration is set-up via the menu (see section [Configure Relays](#)).

Only a qualified person should make electrical connections to the system.

Ensure the power is isolated.

Cable glands should meet the requirements of [Cable Gland Selection and Cord Anchorage](#).

Cable insulation and conductor sizes must meet the requirements of [Cable Conductor Sizes and Insulation Requirements](#).



If using armoured cable, the armour must not be used as the main earth connection for the BIOGAS 3000. If earthing of the armour is required, this must not be taken from the BIOGAS 3000.

All cables should be crimped with an appropriate insulated ferrule for the size of the cable being used. In addition, the cable insulation must be housed adequately within the protective sheath of the ferrule.

The maximum rated voltage of the relays is 24Vdc. Exceeding this voltage will invalidate the hazardous area certification.

Terminals that are wired or unused should be tightened to a minimum of 0.6 N·m. Failure to tighten to this requirement could make the equipment unsafe resulting in a hazard and invalidate the hazardous area certification.

The system comes equipped with eight available relays. The relays are volt free changeover contacts. The maximum rated voltage is 24Vdc.

When being used for alarms and fault notifications the relays are normally energised (i.e. will de-energise when an alarm condition is triggered). This means wiring across connections 11 and 12 during a notification will complete the circuit and de-energise the relay. Refer to [Wiring Diagram 4 – Relays](#) for further information.

## Operating Manual

When being used for sample point indication, catchpot notifications and air purge notifications, the relays are normally de-energised (i.e. will energise when the condition is active). This means wiring across connections 11 and 14 during a notification will complete the circuit and energise the relay. Refer to [Wiring Diagram 4 – Relays](#) for further information.

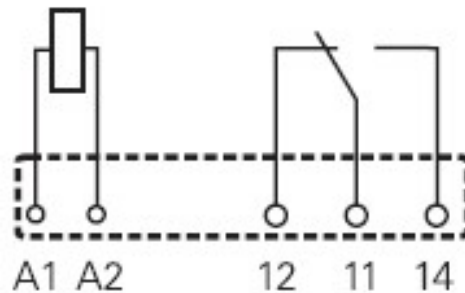

Wiring Diagram 4 – Relays

**Note:** For terminal conductor sizes and cable insulation requirements, please refer to section [Cable Conductor Sizes and Insulation Requirements](#).

### Profibus Digital Output

The Profibus option for the BIOGAS 3000 is via a Modbus to Profibus converter module. The converter is a Profibus slave module and acts as an interface between the Modbus output of the BIOGAS 3000 and Profibus network.



The Modbus to Profibus converter module for the BIOGAS 3000 is not ATEX or IECEx certified and must be housed in a non-hazardous location or within a flameproof enclosure. This is the responsibility of the owner of the equipment.

The BIOGAS 3000 Modbus terminals must only be used for standard Modbus communications; no other connections must be made. Connections outside of this could make the equipment unsafe resulting in a hazard and invalidate the hazardous area certification.

**Note:** The Profibus module can be purchased as a post-sale accessory and upgraded on site by the user; see QED part number BG3K.S3 in [BIOGAS 3000 Consumable Products](#).

For wiring to the Modbus terminals from the Profibus module, see section [Modbus Digital Output](#).

### Configuration of the Profibus Module

The Profibus module node address is currently set to '02'. This can be adjusted, if required, by using the small rotary switches underneath a cap found on the front face of the module (see [Figure 10 - Profibus module switch location](#)). The '0' is set using switch 'A' and the '2' is set using switch 'B' (see



## Operating Manual

[Figure 11 - Profibus module switch identification](#)).

Note: The Profibus configuration GSD file required for setting up the master Profibus communications is enclosed on the supplied CD.



Figure 10 - Profibus module switch location



Figure 11 - Profibus module switch identification

In addition, the Modbus port on the BIOGAS 3000 must be configured as followed:

Node Address	1
Baud Rate	9600
Parity	Even
Stop Bits	1
Termination	On
The BIOGAS 3000 acts as a slave.	

To configure the Modbus port on the BIOGAS 3000, refer to section [Configure Modbus Slave](#) in this operating manual.

## Operating Manual

### Wiring the Profibus Module

Only a qualified person should make electrical connections to the system.

Ensure the power is isolated.

Cable glands should meet the requirements of [Cable Gland Selection and Cord Anchorage](#).

Cable insulation and conductor sizes must meet the requirements of [Cable Conductor Sizes and Insulation Requirements](#).

If using armoured cable, the armour must not be used as the main earth connection for the BIOGAS 3000. If earthing of the armour is required, this must not be taken from the BIOGAS 3000.



The power supply for the Modbus to Profibus converter module must not be taken from the BIOGAS 3000. Using the supply from the BIOGAS 3000 could make the equipment unsafe resulting in a hazard and invalidate the hazardous area certification.

All cables should be crimped with an appropriate insulated ferrule for the size of the cable being used. In addition, the cable insulation must be housed adequately within the protective sheath of the ferrule.

Terminals that are wired or unused should be tightened to a minimum of 0.6 N.m. Failure to tighten to this requirement could make the equipment unsafe resulting in a hazard and invalidate the hazardous area certification.

The input voltage range to the BIOGAS 3000 Modbus terminals must not exceed -7 to +12V and the current must not exceed 83.3mA. Operating outside of this range will invalidate the hazardous area certification.

Wire the outputs in accordance with [Wiring Diagram 5 – Modbus to Profibus converter module wiring](#). In addition, [Wiring Diagram 2 – Modbus](#) may also be useful for wiring to the BIOGAS 3000 Modbus outputs.

For optimum performance, it is recommended that screened twisted pair cable be used.

**Note:** Please refer to section [Cable Conductor Sizes and Insulation Requirements](#).

**Note:** If the distance between the BIOGAS 3000 and the Profibus converter module is greater than 200m, it may be necessary to add a termination resistor at the Profibus end to ensure noise-free communications. In this case, place a 200ohms (0.25W) resistor across the two data line terminals pins one and two on the Furse ESP SL06/I.

For further information, please contact your local distributor, or our technical support team at QED on +44(0)333 800 0088 or email [technical@qedenv.co.uk](mailto:technical@qedenv.co.uk).

## Operating Manual

For cable conductor sizes and cable insulation requirements, when wiring the Modbus connections, the twisted pairs must be as follows:

Terminal Colour	Wiring Information	Pair
Orange	Signal A (RS485) '+'	Pair one
Blue	Signal B (RS485) '-'	
White	Logic Ground (0V) 'LG'	Pair two

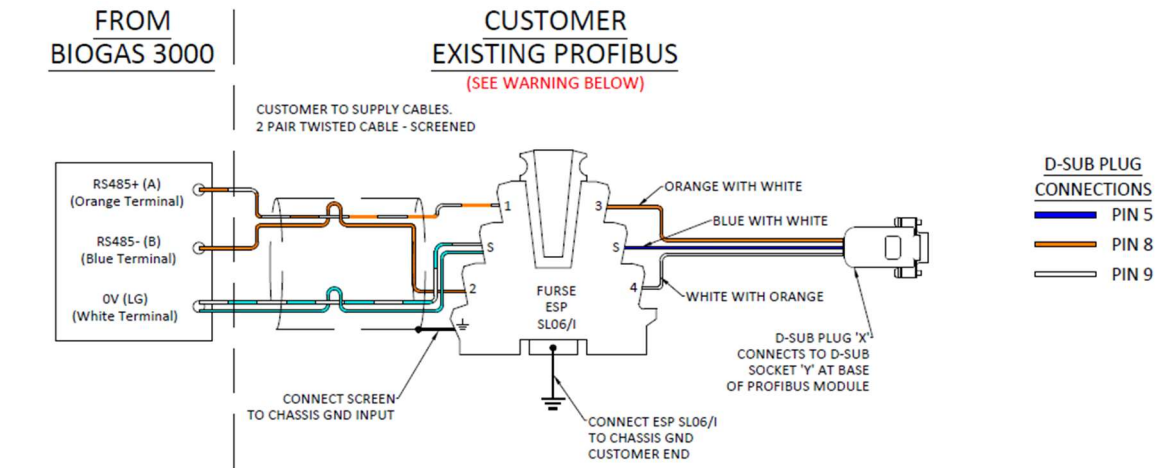

### BASE OF PROFIBUS MODULE

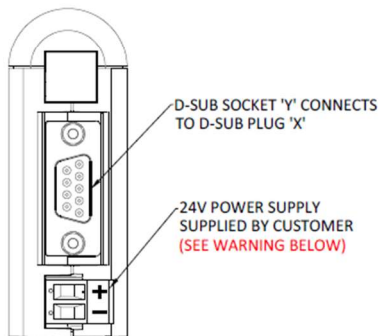

### FRONT OF PROFIBUS MODULE

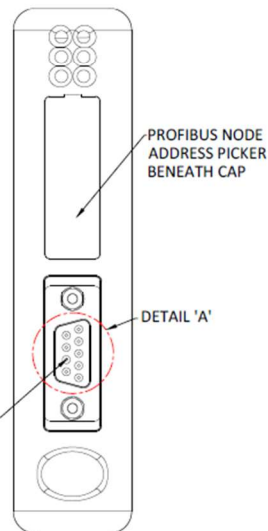

### VIEW OF DETAIL 'A'

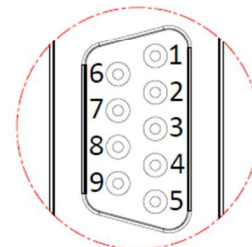

Profibus Module Pin Details	
Pin No	Input/Output
1	N/A
2	N/A
3	B-Line Rx/Tx
4	RTS
5	GND Bus (Output)
6	+5 Bus (Output)
7	N/A
8	A-Line Rx/Tx
9	N/A

### WARNING:

The 24Vdc supply must not be from the BIOGAS 3000 system. Taking this supply voltage from the BIOGAS 3000 will invalidate the ATEX & IECEx certification. The Modbus to Profibus converter module is not ATEX or IECEx Certified and must be housed in a non-hazardous location or within a flameproof enclosure.

### NOTE:

D-SUB PLUG 'X' AND CABLE ASSEMBLY CONTAINS AN EMBEDDED RESISTOR NETWORK AND IS SUPPLIED WITH THE PROFIBUS MODULE KIT

PROFIBUS CONNECTOR FROM EXISTING NETWORK TO BE SUPPLIED BY CUSTOMER

Wiring Diagram 5 – Modbus to Profibus converter module wiring

## Operating Manual

### Readable Parameters of the Profibus Module

The data available to the Profibus network is two (16-bit) words, each word occupying two hex address locations as follows:

Module Internal Name	Parameter	Example
0x0000	Sample Point 1 Last Reading: Year	e.g. 0x07E0 (2016 dec) is 2016 or High Byte 7x256 +Low Byte 0x224
0x0002	Sample Point 1 Last Reading: Month	
0x0004	Sample Point 1 Last Reading: Day	
0x0006	Sample Point 1 Last Reading:	
0x0008	Sample Point 1 Last Reading:	
0x000A	Sample Point 1 Last Reading: Second	
0x000C	Sample Point 1 Last Reading: CH4 x 10	e.g. 0x0259 (601 dec) is 60.1% or High Byte 2x256 +Low Byte 0x89
0x000E	Sample Point 1 Last Reading: CO2 x 10	
0x0010	Sample Point 1 Last Reading: O2 x 10	
0x0012	Sample Point 1 Last Reading: Internal Cell	e.g. 0x03E8 (1000 dec) is 1000ppm or High Byte 3x256 +Low Byte 0x232
0x0014	Sample Point 1 Last Reading:	
0x0016	Sample Point 1 Last Reading: Gas Flow	e.g. 0x0122 (290 dec) is 290ml/min or High Byte 1x256 +Low Byte 0x34
0x0018	Barometric Pressure	e.g. 0x03E1 (993 dec) is 993mbar or High Byte 3x256 +Low Byte 0x225
0x001A	Sample Point 2 Last Reading: Year	e.g. 0x07E0 (2016 dec) is 2016 or High Byte 7x256 +Low Byte 0x224
0x001C	Sample Point 2 Last Reading:	

## Operating Manual

	Month	
0x001E	Sample Point 2 Last Reading: Day	
0x0020	Sample Point 2 Last Reading: Hour	
0x0022	Sample Point 2 Last Reading: Minute	
0x0024	Sample Point 2 Last Reading: Second	
0x0026	Sample Point 2 Last Reading: CH4 x 10	e.g. 0x0259 (601 dec) is 60.1% or High Byte 2x256 +Low Byte 0x89
0x0028	Sample Point 2 Last Reading: CO2 x 10	
0x002A	Sample Point 2 Last Reading: O2 x 10	
0x002C	Sample Point 2 Last Reading: Internal Cell	e.g. 0x03E8 (1000 dec) is 1000ppm or High Byte 3x256 +Low Byte 0x232
0x002E	Sample Point 2 Last Reading: External cell	
0x0030	Sample Point 2 Last Reading: Gas Flow	e.g. 0x0122 (290 dec) is 290ml/min or High Byte 1x256 +Low Byte 0x34
0x0032	Sample Point 3 Last Reading: Year	e.g. 0x07E0 (2016 dec) is 2016 or High Byte 7x256 +Low Byte 0x224
0x0034	Sample Point 3 Last Reading: Month	
0x0036	Sample Point 3 Last Reading: Day	
0x0038	Sample Point 3 Last Reading: Hour	
0x003A	Sample Point 3 Last Reading: Minute	
0x003C	Sample Point 3 Last Reading: Second	
0x003E	Sample Point 3 Last Reading:	e.g. 0x0259 (601 dec) is 60.1% or High Byte 2x256

## Operating Manual

	CH4 x 10	+Low Byte 0x89
0x0040	Sample Point 3 Last Reading: CO2 x 10	
0x0042	Sample Point 3 Last Reading: O2 x 10	
0x0044	Sample Point 3 Last Reading: Internal Cell	e.g. 0x03E8 (1000 dec) is 1000ppm or High Byte 3x256 +Low Byte 0x232
0x0046	Sample Point 3 Last Reading: External cell	
0x0048	Sample Point 3 Last Reading: Gas Flow	e.g. 0x0122 (290 dec) is 290ml/min or High Byte 1x256 +Low Byte 0x34
0x004A	Sample Point 4 Last Reading: Year	e.g. 0x07E0 (2016 dec) is 2016 or High Byte 7x256 +Low Byte 0x224
0x004C	Sample Point 4 Last Reading: Month	
0x004E	Sample Point 4 Last Reading: Day	
0x0050	Sample Point 4 Last Reading: Hour	
0x0052	Sample Point 4 Last Reading: Minute	
0x0054	Sample Point 4 Last Reading: Second	
0x0056	Sample Point 4 Last Reading: CH4 x 10	e.g. 0x0259 (601 dec) is 60.1% or High Byte 2x256 +Low Byte 0x89
0x0058	Sample Point 4 Last Reading: CO2 x 10	
0x005A	Sample Point 4 Last Reading: O2 x 10	
0x005C	Sample Point 4 Last Reading: Internal Cell	e.g. 0x03E8 (1000 dec) is 1000ppm or High Byte 3x256 +Low Byte 0x232
0x005E	Sample Point 4 Last Reading: External cell	
0x0060	Sample Point 4 Last Reading:	e.g. 0x0122 (290 dec) is 290ml/min or High Byte 1x256

## Operating Manual

	Gas Flow	+Low Byte 0x34
0x0062	Alarm 1	0= No Alarm,
0x0064	Alarm 2	1=Triggered,
0x0066	Alarm 3	2=Triggered and in recovery zone
0x0068	Alarm 4	4 = Latched
0x006A	Alarm 5	8 = Muted
0x006C	Alarm 6	9 = Triggered alarm and muted
0x006E	Alarm 7	A = Recovering alarm and muted
0x0080	Current sample Point	1 to 4

The Profibus module updates the readings from the BIOGAS 3000 every 2.5 seconds.

Successful communication between the Modbus output and the Profibus module is indicated by the subnet status light '5' on the module showing green. If for any reason the communications is intermittent or fails, the light flashes red or is permanently red, and the value being read is cleared to zero and not frozen with a previous value. Monitoring for an example the year, month and day for non-zero values will gain confidence that communications is ongoing.

## Operating Manual

### Profinet Digital Output

The Profinet option for the BIOGAS 3000 is via a Modbus to Profinet converter module. The converter is a Profinet slave module and acts as an interface between the Modbus output of the BIOGAS 3000 and Profinet network.



The Modbus to Profinet converter module for the BIOGAS 3000 is not ATEX or IECEx certified and must be housed in a non-hazardous location or within a flameproof enclosure. This is the responsibility of the owner of the equipment.

The BIOGAS 3000 Modbus terminals must only be used for standard Modbus communications; no other connections must be made. Connections outside of this could make the equipment unsafe resulting in a hazard and invalidate the hazardous area certification.

**Note:** The Profinet module can be purchased as a post-sale accessory and upgraded on site by the user, see QED part number BG3K.S4 in [BIOGAS 3000 Consumable Products](#).

For wiring to the Modbus terminals from the Profibus module, see section [Modbus Digital Output](#).

### Configuration of the Profinet Module

The Profinet module can be configured using the GSDML file supplied on the enclosed CD. Follow the instructions on the supplied installation sheet to configure the module for the Profinet sub-network.

In addition, the Modbus port on the BIOGAS 3000 must be configured as followed:

Node Address	1
Baud Rate	9600
Parity	Even
Stop Bits	1
Termination	On
The BIOGAS 3000 acts as a slave.	

To configure the Modbus port on the BIOGAS 3000, refer to section [Configure Modbus Slave](#) in this operating manual.



## Operating Manual

## Wiring the Profinet Module

Only a qualified person should make electrical connections to the system.

Ensure the power is isolated.

Cable glands should meet the requirements of [Cable Gland Selection and Cord Anchorage](#).

Cable insulation and conductor sizes must meet the requirements of [Cable Conductor Sizes and Insulation Requirements](#).

If using armoured cable, the armour must not be used as the main earth connection for the BIOGAS 3000. If earthing of the armour is required, this must not be taken from the BIOGAS 3000.



The power supply for the Modbus to Profinet converter module must not be taken from the BIOGAS 3000. Using the supply from the BIOGAS 3000 could make the equipment unsafe resulting in a hazard and invalidate the hazardous area certification.

All cables should be crimped with an appropriate insulated ferrule for the size of the cable being used. In addition, the cable insulation must be housed adequately within the protective sheath of the ferrule.

Terminals that are wired or unused should be tightened to a minimum of 0.6 N·m. Failure to tighten to this requirement could make the equipment unsafe resulting in a hazard and invalidate the hazardous area certification.

The input voltage range to the BIOGAS 3000 Modbus terminals must not exceed -7 to +12V and the current must not exceed 83.3mA. Operating outside of this range will invalidate the hazardous area certification.

Wire the outputs in accordance with [Wiring Diagram 6 - Modbus to Profinet converter module wiring](#).

In addition, [Wiring Diagram 2 – Modbus](#) may also be useful for wiring to the BIOGAS 3000 Modbus outputs.

For optimum performance, it is recommended that screened twisted pair cable be used.

**Note:** For cable conductor sizes and cable insulation requirements, please refer to section [Cable Conductor Sizes and Insulation Requirements](#).

**Note:** If the distance between the BIOGAS 3000 and the Profinet converter module is greater than 200m, it may be necessary to add a termination resistor at the Profinet end to ensure noise-free communications. In this case, place a 200ohms (0.25W) resistor across the two data line terminals pins one and two on the Furse ESP SL06/I.

For further information please contact your local distributor, or our technical support team at QED on +44(0)333 800 0088 or email [technical@qedenv.co.uk](mailto:technical@qedenv.co.uk).

## Operating Manual

When wiring the Modbus connections, the twisted pairs must be as follows:

Terminal Colour	Wiring Information	Pair
Orange	Signal A (RS485) '+'	Pair one
Blue	Signal B (RS485) '-'	
White	Logic Ground (0V) 'LG'	Pair two

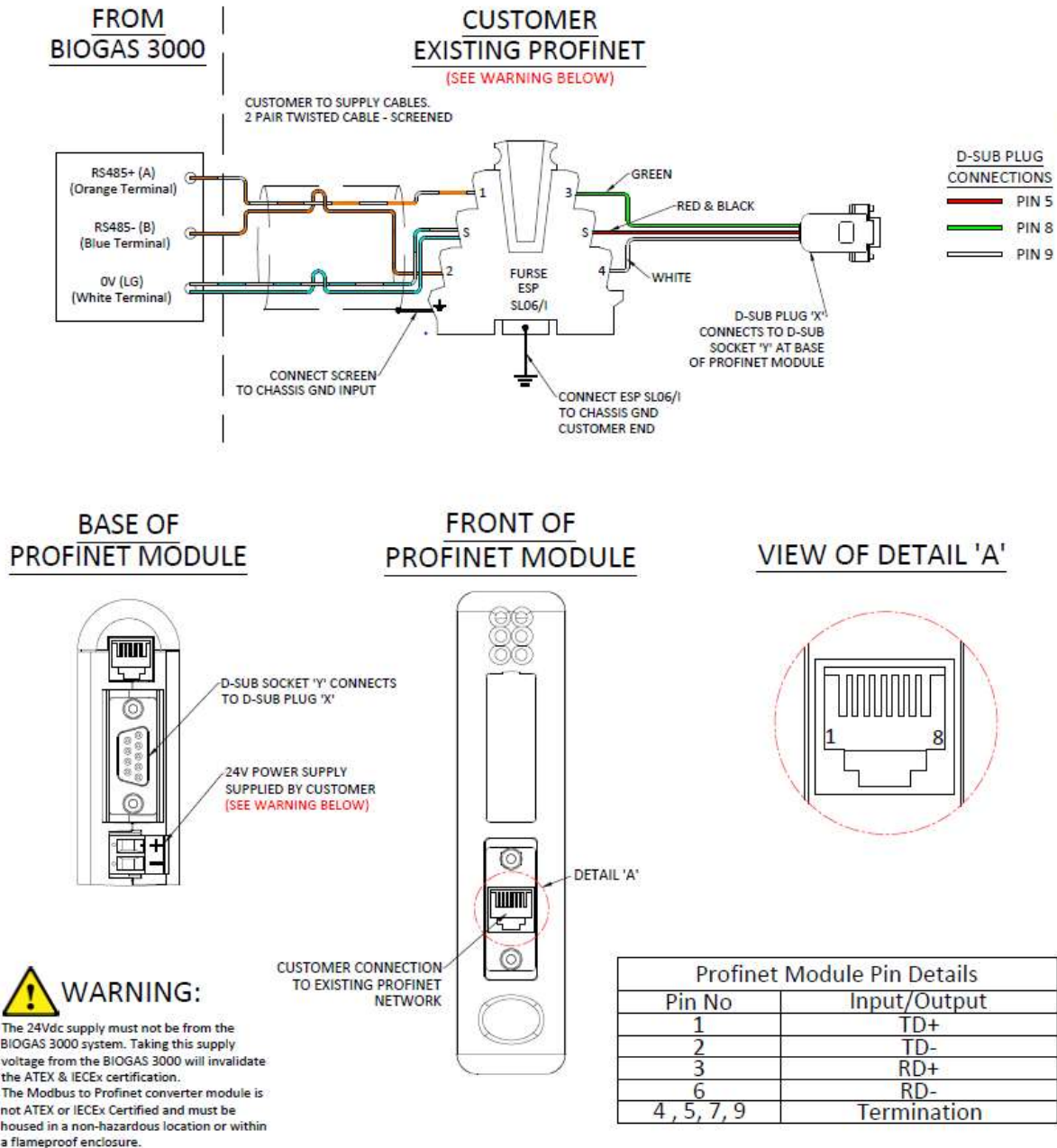

NOTE:

D-SUB PLUG 'X' AND CABLE ASSEMBLY IS SUPPLIED WITH THE PROFINET MODULE KIT  
PROFINET CONNECTOR FROM EXISTING NETWORK TO BE SUPPLIED BY CUSTOMER



IF IN DOUBT ASK



Wiring Diagram 6 - Modbus to Profinet converter module wiring

## Operating Manual

### Readable Parameters of the Profinet Module

The data available to the Profinet network is two (16-bit) words, each word occupying two hex address locations as follows:

Module Internal Name	Parameter	Example
0x0000	Sample Point 1 Last Reading: Year	e.g. 0x07E0 (2016 dec) is 2016 or High Byte 7x256 +Low Byte 0x224
0x0002	Sample Point 1 Last Reading: Month	
0x0004	Sample Point 1 Last Reading: Day	
0x0006	Sample Point 1 Last Reading:	
0x0008	Sample Point 1 Last Reading:	
0x000A	Sample Point 1 Last Reading: Second	
0x000C	Sample Point 1 Last Reading: CH4 x 10	e.g. 0x0259 (601 dec) is 60.1% or High Byte 2x256 +Low Byte 0x89
0x000E	Sample Point 1 Last Reading: CO2 x 10	
0x0010	Sample Point 1 Last Reading: O2 x 10	
0x0012	Sample Point 1 Last Reading: Internal Cell	e.g. 0x03E8 (1000 dec) is 1000ppm or High Byte 3x256 +Low Byte 0x232
0x0014	Sample Point 1 Last Reading:	
0x0016	Sample Point 1 Last Reading: Gas Flow	e.g. 0x0122 (290 dec) is 290ml/min or High Byte 1x256 +Low Byte 0x34
0x0018	Barometric Pressure	e.g. 0x03E1 (993 dec) is 993mbar or High Byte 3x256 +Low Byte 0x225
0x001A	Sample Point 2 Last Reading: Year	e.g. 0x07E0 (2016 dec) is 2016 or High Byte 7x256 +Low Byte 0x224
0x001C	Sample Point 2 Last Reading: Month	

## Operating Manual

0x001E	Sample Point 2 Last Reading: Day	
0x0020	Sample Point 2 Last Reading: Hour	
0x0022	Sample Point 2 Last Reading: Minute	
0x0024	Sample Point 2 Last Reading: Second	
0x0026	Sample Point 2 Last Reading: CH4 x 10	e.g. 0x0259 (601 dec) is 60.1% or High Byte 2x256 +Low Byte 0x89
0x0028	Sample Point 2 Last Reading: CO2 x 10	
0x002A	Sample Point 2 Last Reading: O2 x 10	
0x002C	Sample Point 2 Last Reading: Internal Cell	e.g. 0x03E8 (1000 dec) is 1000ppm or High Byte 3x256 +Low Byte 0x232
0x002E	Sample Point 2 Last Reading: External cell	
0x0030	Sample Point 2 Last Reading: Gas Flow	e.g. 0x0122 (290 dec) is 290ml/min or High Byte 1x256 +Low Byte 0x34
0x0032	Sample Point 3 Last Reading: Year	e.g. 0x07E0 (2016 dec) is 2016 or High Byte 7x256 +Low Byte 0x224
0x0034	Sample Point 3 Last Reading: Month	
0x0036	Sample Point 3 Last Reading: Day	
0x0038	Sample Point 3 Last Reading: Hour	
0x003A	Sample Point 3 Last Reading: Minute	
0x003C	Sample Point 3 Last Reading: Second	
0x003E	Sample Point 3 Last Reading: CH4 x 10	e.g. 0x0259 (601 dec) is 60.1% or High Byte 2x256 +Low Byte 0x89
0x0040	Sample Point 3 Last Reading: CO2 x 10	
0x0042	Sample Point 3 Last Reading: O2 x 10	

## Operating Manual

0x0044	Sample Point 3 Last Reading: Internal Cell	e.g. 0x03E8 (1000 dec) is 1000ppm or High Byte 3x256 +Low Byte 0x232
0x0046	Sample Point 3 Last Reading: External cell	
0x0048	Sample Point 3 Last Reading: Gas Flow	e.g. 0x0122 (290 dec) is 290ml/min or High Byte 1x256 +Low Byte 0x34
0x004A	Sample Point 4 Last Reading: Year	e.g. 0x07E0 (2016 dec) is 2016 or High Byte 7x256 +Low Byte 0x224
0x004C	Sample Point 4 Last Reading: Month	
0x004E	Sample Point 4 Last Reading: Day	
0x0050	Sample Point 4 Last Reading: Hour	
0x0052	Sample Point 4 Last Reading: Minute	
0x0054	Sample Point 4 Last Reading: Second	
0x0056	Sample Point 4 Last Reading: CH4 x 10	e.g. 0x0259 (601 dec) is 60.1% or High Byte 2x256 +Low Byte 0x89
0x0058	Sample Point 4 Last Reading: CO2 x 10	
0x005A	Sample Point 4 Last Reading: O2 x 10	
0x005C	Sample Point 4 Last Reading: Internal Cell	e.g. 0x03E8 (1000 dec) is 1000ppm or High Byte 3x256 +Low Byte 0x232
0x005E	Sample Point 4 Last Reading: External cell	
0x0060	Sample Point 4 Last Reading: Gas Flow	e.g. 0x0122 (290 dec) is 290ml/min or High Byte 1x256 +Low Byte 0x34
0x0062	Alarm 1	0= No Alarm,
0x0064	Alarm 2	1=Triggered,
0x0066	Alarm 3	2=Triggered and in recovery zone
0x0068	Alarm 4	4 = Latched
0x006A	Alarm 5	8 = Muted

## Operating Manual

0x006C	Alarm 6	9 = Triggered alarm and muted
0x006E	Alarm 7	A = Recovering alarm and muted
0x0080	Current sample Point	1 to 4

The Profinet module updates the readings from the BIOGAS 3000 every 2.5 seconds.

Successful communication between the Modbus output and the Profinet module is indicated by the subnet status light '5' on the module showing green. If for any reason the communications is intermittent or fails, the light flashes red or is permanently red, and the value being read is cleared to zero and not frozen with a previous value. Monitoring for an example the year, month and day for non-zero values will gain confidence that communications is ongoing.

### Ethernet Digital Output

The Ethernet option for the BIOGAS 3000 is via a Modbus to Ethernet converter module. The converter is an Ethernet slave module and acts as an interface between the Modbus output of the BIOGAS 3000 and Ethernet network.



The Ethernet Digital module does not grant access to the QED customer portal. To enable remote support functionality, please see section [Wiring the Ethernet Input](#)



The Modbus to Ethernet converter module for the BIOGAS 3000 is not ATEX or IECEx certified and must be housed in a non-hazardous location or within a flameproof enclosure. This is the responsibility of the owner of the equipment.

The BIOGAS 3000 Modbus terminals must only be used for standard Modbus communications; no other connections must be made. Connections outside of this could make the equipment unsafe resulting in a hazard and invalidate the hazardous area certification.

**Note:** The Ethernet module can be purchased as a post-sale accessory and upgraded on site by the user; see QED part number BG3K.S40 in [BIOGAS 3000 Consumable Products](#).

For wiring to the Modbus terminals from the Ethernet module, see section [Modbus Digital Output](#).

## Operating Manual

### Configuration of the Ethernet Module

The Ethernet module IP address is currently set to 192.168.0.1. This can be changed, if required, by using the software provided via the enclosed CD.

**Note:** The Ethernet configuration EDS file required for setting up the master Ethernet communications is enclosed on the supplied CD.

In addition, the Modbus port on the BIOGAS 3000 must be configured as followed:

Node Address	1
Baud Rate	9600
Parity	Even
Stop Bits	1
Termination	On
The BIOGAS 3000 acts as a slave.	

To configure the Modbus port on the BIOGAS 3000, refer to section [Configure Modbus Slave](#) in this operating manual.

### Wiring the Ethernet Module

Only a qualified person should make electrical connections to the system.

Ensure the power is isolated.

Cable glands should meet the requirements of [Cable Gland Selection and Cord Anchorage](#).

Cable insulation and conductor sizes must meet the requirements of [Cable Conductor Sizes and Insulation Requirements](#).



If using armoured cable, the armour must not be used as the main earth connection for the BIOGAS 3000. If earthing of the armour is required, this must not be taken from the BIOGAS 3000.

The power supply for the Modbus to Ethernet converter module must not be taken from the BIOGAS 3000. Using the supply from the BIOGAS 3000 could make the equipment unsafe resulting in a hazard and invalidate the hazardous area certification.

All cables should be crimped with an appropriate insulated ferrule for the size of the cable being used. In addition, the cable insulation must be housed adequately within the protective sheath of the ferrule.

Terminals that are wired or unused should be tightened to a minimum of 0.6 N.m. Failure to tighten to this requirement could make the equipment unsafe resulting in a hazard and

## Operating Manual

invalidate the hazardous area certification.

The input voltage range to the BIOGAS 3000 Modbus terminals must not exceed -7 to +12V and the current must not exceed 83.3mA. Operating outside of this range will invalidate the hazardous area certification.

Wire the outputs in accordance with [Wiring Diagram 5 – Modbus to Profibus converter module wiring](#). In addition, [Wiring Diagram 2 – Modbus](#) may also be useful for wiring to the BIOGAS 3000 Modbus outputs.

For optimum performance, it is recommended that screened twisted pair cable be used.

**Note:** For cable conductor sizes and cable insulation requirements, please refer to section [Cable Conductor Sizes and Insulation Requirements](#).

**Note:** If the distance between the BIOGAS 3000 and the Ethernet converter module is greater than 200m, it may be necessary to add a termination resistor at the Ethernet end to ensure noise-free communications. In this case, place a 200ohms (0.25W) resistor across the two data line terminals pins one and two on the Furse ESP SL06/I.

For further information please contact your local distributor, or our technical support team at QED on +44(0)333 800 0088 or email [technical@qedenv.co.uk](mailto:technical@qedenv.co.uk).

When wiring the Ethernet connections, the twisted pairs must be as follows:

Terminal Colour	Wiring Information	Pair
Orange	Signal A (RS485) '+'	Pair one
Blue	Signal B (RS485) '-'	
White	Logic Ground (0V) 'LG'	Pair two



## Operating Manual

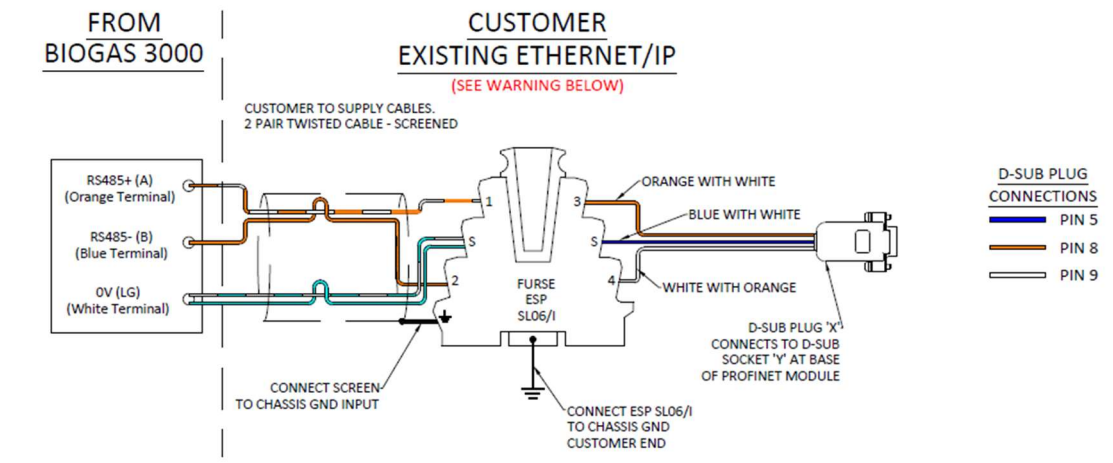

### BASE OF ETHERNET/IP MODULE

### FRONT OF ETHERNET/IP MODULE

### VIEW OF DETAIL 'A'

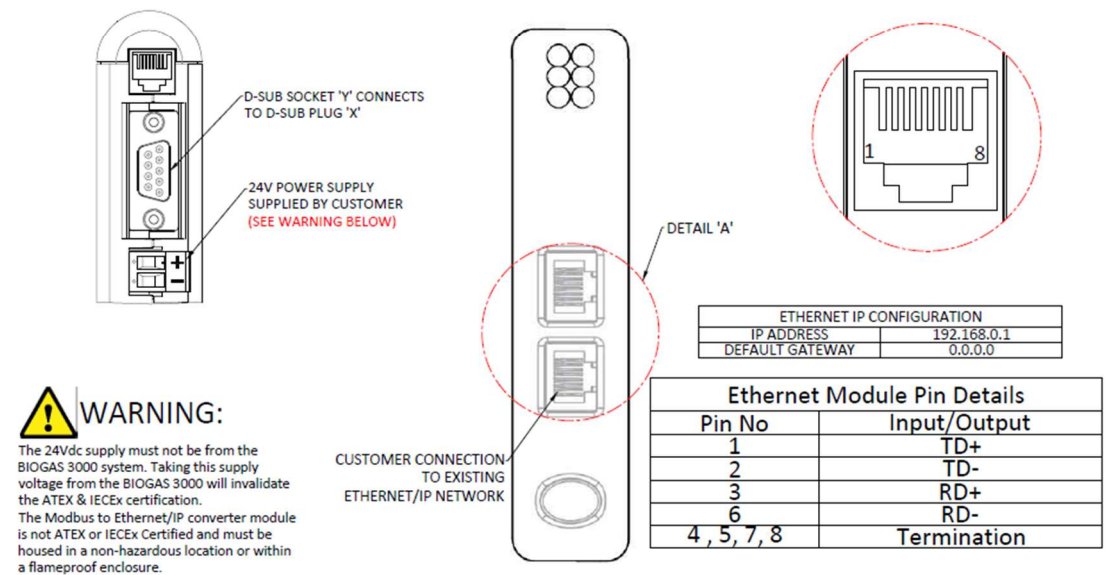

**WARNING:**

The 24Vdc supply must not be from the BIOGAS 3000 system. Taking this supply voltage from the BIOGAS 3000 will invalidate the ATEX & IECEx certification. The Modbus to Ethernet/IP converter module is not ATEX or IECEx Certified and must be housed in a non-hazardous location or within a flameproof enclosure.

**NOTE:**

D-SUB PLUG 'X' AND CABLE ASSEMBLY IS SUPPLIED WITH THE ETHERNET/IP MODULE KIT

ETHERNET/IP CONNECTOR FROM EXISTING NETWORK TO BE SUPPLIED BY CUSTOMER

Wiring Diagram 7 – Modbus to Ethernet converter module wiring

## Operating Manual

### Readable Parameters of the Ethernet Module

The data available to the Ethernet network is two (16-bit) words, each word occupying two hex address locations as follows:

Module Internal Name	Parameter	Example
0x0000	Sample Point 1 Last Reading: Year	e.g. 0x07E0 (2016 dec) is 2016 or High Byte 07x256 +Low Byte 0x224  EO Hex = 224 dec
0x0002	Sample Point 1 Last Reading: Month	
0x0004	Sample Point 1 Last Reading: Day	
0x0006	Sample Point 1 Last Reading: Hour	
0x0008	Sample Point 1 Last Reading: Minute	
0x000A	Sample Point 1 Last Reading: Second	
0x000C	Sample Point 1 Last Reading: CH4 x 10	e.g. 0x0259 (601 dec) is 60.1% or High Byte 2x256 +Low Byte 0x89
0x000E	Sample Point 1 Last Reading: CO2 x 10	
0x0010	Sample Point 1 Last Reading: O2 x 10	
0x0012	Sample Point 1 Last Reading: Internal Cell	e.g. 0x03E8 (1000 dec) is 1000ppm or High Byte 3x256 +Low Byte 0x232
0x0014	Sample Point 1 Last Reading: External Cell	e.g. 0x03E8 (1000 dec) is 1000ppm or High Byte 3x256 +Low Byte 0x232
0x0016	Sample Point 1 Last Reading: Gas Flow	e.g. 0x0122 (290 dec) is 290ml/min or High Byte 1x256 +Low Byte 0x34
0x0018	Barometric Pressure	e.g. 0x03E1 (993 dec) is 993mbar or High Byte 3x256 +Low Byte 0x225
0x001A	Sample Point 2 Last Reading: Year	e.g. 0x07E0 (2016 dec) is 2016 or High Byte 7x256 +Low Byte 0x224
0x001C	Sample Point 2 Last Reading: Month	

## Operating Manual

0x001E	Sample Point 2 Last Reading: Day	
0x0020	Sample Point 2 Last Reading: Hour	
0x0022	Sample Point 2 Last Reading: Minute	
0x0024	Sample Point 2 Last Reading: Second	
0x0026	Sample Point 2 Last Reading: CH4 x 10	e.g. 0x0259 (601 dec) is 60.1% or High Byte 2x256 +Low Byte 0x89
0x0028	Sample Point 2 Last Reading: CO2 x 10	
0x002A	Sample Point 2 Last Reading: O2 x 10	
0x002C	Sample Point 2 Last Reading: Internal Cell	e.g. 0x03E8 (1000 dec) is 1000ppm or High Byte 3x256 +Low Byte 0x232
0x002E	Sample Point 2 Last Reading: External cell	e.g. 0x03E8 (1000 dec) is 1000ppm or High Byte 3x256 +Low Byte 0x232
0x0030	Sample Point 2 Last Reading: Gas Flow	e.g. 0x0122 (290 dec) is 290ml/min or High Byte 1x256 +Low Byte 0x34
0x0032	Sample Point 3 Last Reading: Year	e.g. 0x07E0 (2016 dec) is 2016 or High Byte 7x256 +Low Byte 0x224
0x0034	Sample Point 3 Last Reading: Month	
0x0036	Sample Point 3 Last Reading: Day	
0x0038	Sample Point 3 Last Reading: Hour	
0x003A	Sample Point 3 Last Reading: Minute	
0x003C	Sample Point 3 Last Reading: Second	
0x003E	Sample Point 3 Last Reading: CH4 x 10	e.g. 0x0259 (601 dec) is 60.1% or High Byte 2x256 +Low Byte 0x89
0x0040	Sample Point 3 Last Reading: CO2 x 10	
0x0042	Sample Point 3 Last Reading: O2 x 10	
0x0044	Sample Point 3 Last Reading: Internal Cell	e.g. 0x03E8 (1000 dec) is 1000ppm or High Byte 3x256 +Low Byte 0x232
0x0046	Sample Point 3 Last Reading: External cell	e.g. 0x03E8 (1000 dec) is 1000ppm or High Byte 3x256 +Low Byte 0x232
0x0048	Sample Point 3 Last Reading: Gas	e.g. 0x0122 (290 dec) is 290ml/min or High

## Operating Manual

	Flow	Byte 1x256 +Low Byte 0x34
0x004A	Sample Point 4 Last Reading: Year	e.g. 0x07E0 (2016 dec) is 2016 or High Byte 7x256 +Low Byte 0x224
0x004C	Sample Point 4 Last Reading: Month	
0x004E	Sample Point 4 Last Reading: Day	
0x0050	Sample Point 4 Last Reading: Hour	
0x0052	Sample Point 4 Last Reading: Minute	
0x0054	Sample Point 4 Last Reading: Second	
0x0056	Sample Point 4 Last Reading: CH <sub>4</sub> x 10	e.g. 0x0259 (601 dec) is 60.1% or High Byte 2x256 +Low Byte 0x89
0x0058	Sample Point 4 Last Reading: CO <sub>2</sub> x 10	
0x005A	Sample Point 4 Last Reading: O <sub>2</sub> x 10	
0x005C	Sample Point 4 Last Reading: Internal Cell	e.g. 0x03E8 (1000 dec) is 1000ppm or High Byte 3x256 +Low Byte 0x232
0x005E	Sample Point 4 Last Reading: External cell	e.g. 0x03E8 (1000 dec) is 1000ppm or High Byte 3x256 +Low Byte 0x232
0x0060	Sample Point 4 Last Reading: Gas Flow	e.g. 0x0122 (290 dec) is 290ml/min or High Byte 1x256 +Low Byte 0x34
0x0062	Alarm 1	0= No Alarm,
0x0064	Alarm 2	1=Triggered,
0x0066	Alarm 3	2=Triggered and in recovery zone
0x0068	Alarm 4	4 = Latched
0x006A	Alarm 5	8 = Muted
0x006C	Alarm 6	9 = Triggered alarm and muted
0x006E	Alarm 7	A = Recovering alarm and muted
0x0080	Current sample Point	1 to 4

The Ethernet module updates the readings from the BIOGAS 3000 every 2.5 seconds.

Successful communication between the Modbus output and the Ethernet module is indicated by the subnet status light '5' on the module showing green. If for any reason the communications is intermittent or fails, the light flashes red or is permanently red, and the value being read is cleared to zero and not frozen with a previous value.

## Operating Manual

For example, if the data in the address locations for either minute or second regularly changes, this will give confidence that communications is active and uninterrupted.

### Wiring the Ethernet Input

The Ethernet connector can be used to connect to the internet and gain access to the QED Customer Portal, allowing remote support functionality.

Ensure the power is isolated.

Cable glands should meet the requirements of [Cable Conductor Sizes and Insulation Requirements](#)

Cable insulation and conductor sizes must meet the requirements of [Cable Conductor Sizes and Insulation Requirements](#)



If using armoured cable, the armour must not be used as the main earth connection for the BIOGAS 3000. If earthing of the armour is required, this must not be taken from the BIOGAS 3000.

The input voltage range to the BIOGAS 3000 Ethernet RJ45 connector must not exceed 2.5Vdc and the current must not exceed 25mA. Operating outside of this range will invalidate the hazardous area certification.

Wire the outputs in accordance with [Wiring Diagram 8](#). The cable must be a minimum specification of Cat6 (or higher), have cable shielding (e.g. F/UTP) and terminate in a shielded RJ45 connector.

Registration and access to the QED Customer Portal is via web address: <https://my.qedenv.com>

For full instructions on using the Portal, please use the Help pages within the portal.

**Note:** For cable conductor sizes and cable insulation requirements, please refer to section [Cable Conductor Sizes and Insulation Requirements](#).

**Note:** A network firewall exception for port 6470 will be required to allow authorised access.



If an internet connection is established using a third party device (e.g. 3G/4G SIM Modem), all necessary precautions need to be taken to ensure the suitability of this device for use in a potentially explosive atmosphere, and adhering to all local site safety procedures.

## Operating Manual

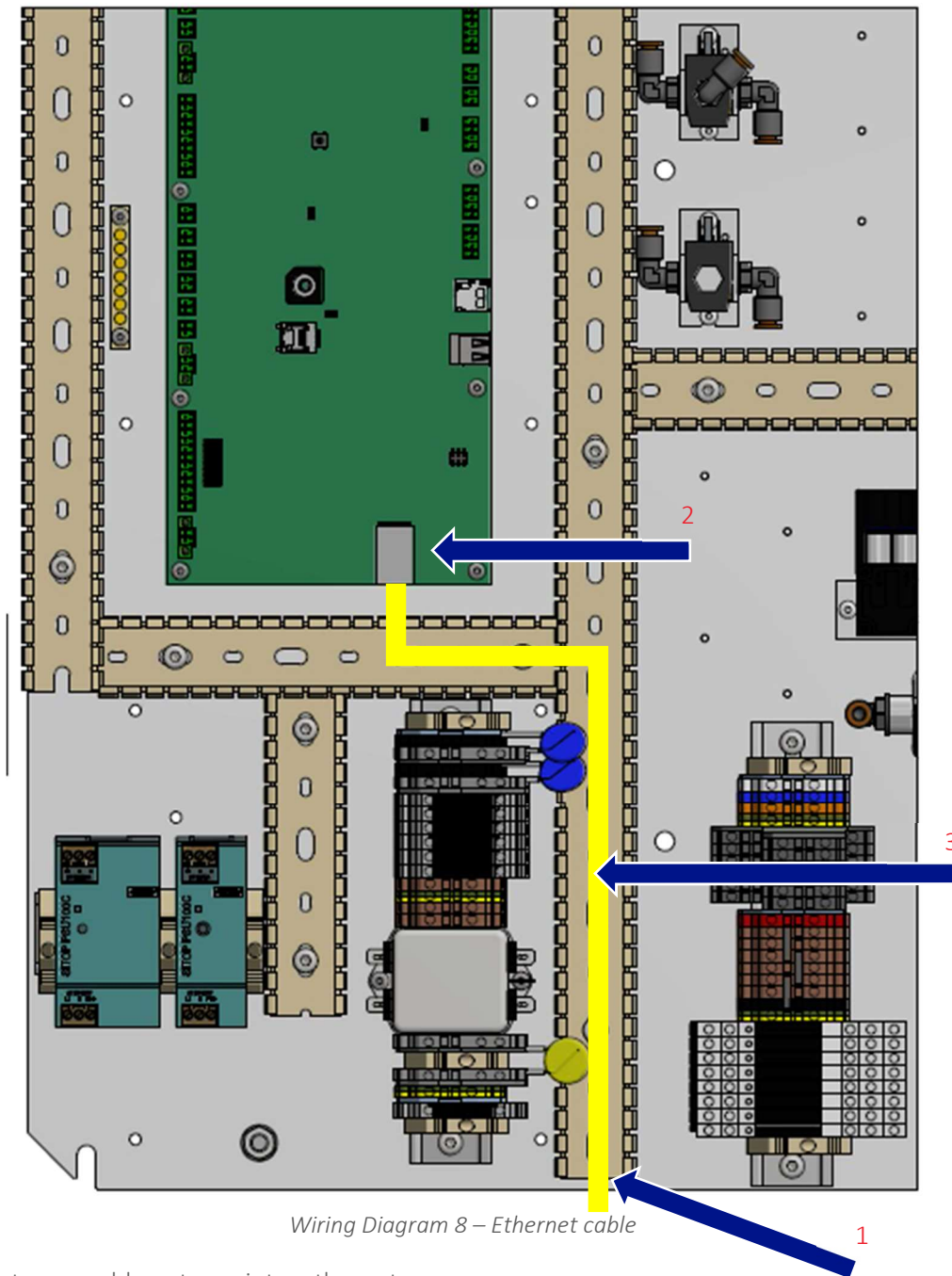

- 1) Customer cable entry point – ethernet
- 2) RJ45 connector (interface board)
- 3) Ethernet cable

### Heater Option

If purchased at the point of sale, the equipment will be fitted with a 100W heater (suitable for the relevant mains input voltage), control thermostat, and enclosure insulation. The thermostat is pre-set to 15°C and cannot be adjusted.

## Operating Manual

### Final Checks

- Ensure all gas connections to the system are leak free – refer to section [Pressure Test](#) of this operating manual for instructions on how to perform this.
- Ensure the gas inlet and gas outlet ball valves are open (refer to annotation 12 on [Figure 2 - BIOGAS 3000 internal components](#)) these must be in the vertical position.
- Ensure the drain ball valve, if fitted, is closed (see annotation 9 on [Figure 2 - BIOGAS 3000 internal components](#)), this must be in the horizontal position.
- Ensure the calibration ball valve is closed (see annotation 10 on [Figure 2 - BIOGAS 3000 internal components](#)), this must be in the vertical position.
- Turn the power on to the system. Within one minute of power being applied, the module will turn on and display the BIOGAS 3000 logo, shortly followed by the ‘system self-test’ screen (see [Screen 3 - System Self-Test](#)).
- The first time the module is started after the self-test has successfully completed, the ‘first time run set-up wizard’ will begin – please refer to section [First Time Configuration](#) in this manual for details of this process.
- It is strongly recommended that a known concentration of gas be passed through the system to ensure that it still reading correctly following installation. Refer to the [Gas Check and Calibration](#) section of this operating manual for further information on this process.

Note: For further information please contact your local distributor, or our technical support team at QED on +44(0)333 800 0088 or email [technical@qedenv.co.uk](mailto:technical@qedenv.co.uk).

## Operating Manual

### GENERAL OPERATING INSTRUCTIONS



Do not open when an explosive atmosphere is present.

#### Switching the BIOGAS 3000 System On

- 1) The module will automatically turn on when power to the system is switched on. If this does not happen, refer to the [Problem Solving](#) section of this operating manual.

Note: It can take up to one minute for the BIOGAS 3000 module to power on. If it does not turn on at the point power to the system is applied, please wait one minute before pressing any keys on the module.

- 2) If the power on is successful, the 'BIOGAS 3000' logo will appear on screen and then the 'System Self-Test' will commence.



Screen 1 - Power on

#### System Start-Up

##### Language Selection

When turned on for the first time, the module will ask the user to select the language for the system. See [Set Language](#) for more information.

##### Time and Date

Following selecting the language, if required, the user will need to enter the correct time and date for the local time zone. See [Set Time and Date](#) for more information.



## Operating Manual

### Interface Board Firmware Update

Before a self-test commences, the module will check that the firmware version of the Interface Board is to the latest revision. If it is not, the user is asked whether they would like to update their firmware:

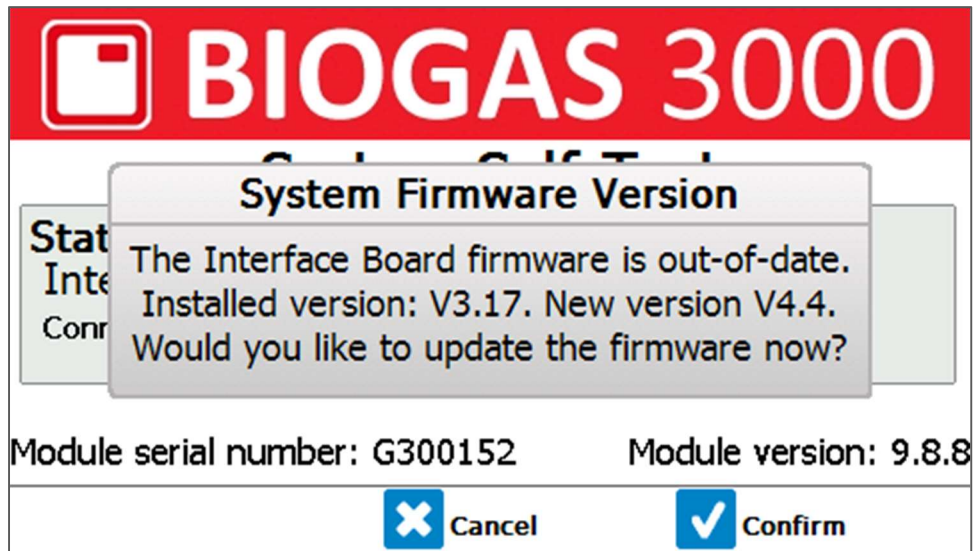

Screen 2 – Interface Board firmware

To update the firmware, press the right soft key 'Confirm' to enable the module to program the Interface Board.

**Note:** This could take several minutes depending on the size of the update. During the update, do not turn off the system.

If you do not wish to update the firmware, press the middle soft key to 'Cancel'. Next time the system or module is restarted; you will be reminded that the firmware version is out of date.

## Operating Manual

### Self-Test

When switched on the module will perform a pre-determined self-test sequence taking approximately sixty seconds. During the self-test, the percentage complete is shown and remains on screen until the self-test is completed.

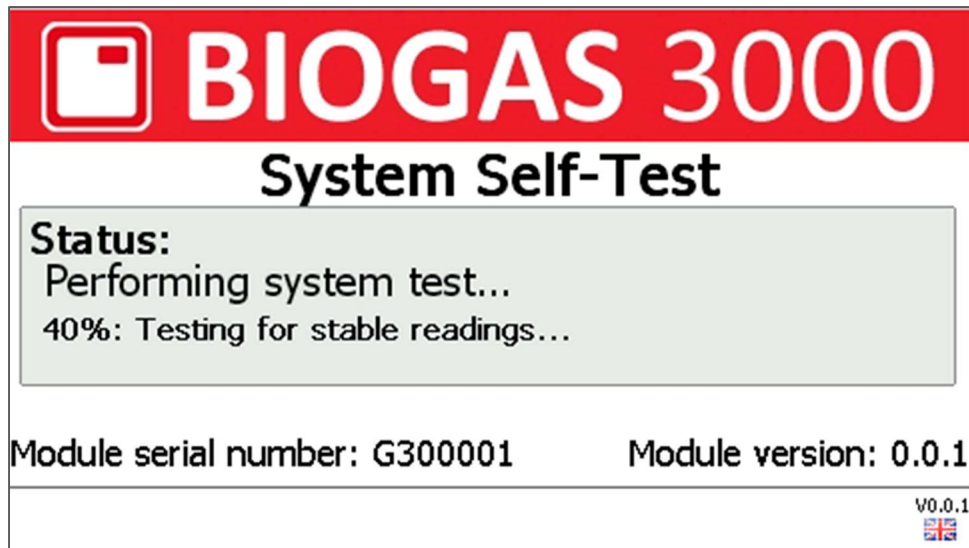

*Screen 3 - System Self-Test*

During this time, many of the system's functions are tested, including:

- The Interface Board firmware is checked to ensure it is the latest version – see [Interface Board Firmware Update](#).
- Testing of the CH<sub>4</sub>, CO<sub>2</sub>, O<sub>2</sub>, reference, barometer, internal cell, external cell, and transducers is performed continuously over a short period to check for faults and instability.
- The pump is switched on and the system checked for blockages.
- The next service due date is checked.
- Valid communications to the Interface PCB is checked.
- Test whether the 'first time configuration' is required.

If no faults are found, then the first time configuration or monitoring will begin.

Note: After completion, if any non-critical failures occur then [Screen 4 - Self-test finished with warnings](#) screen is shown.

Note: If the fault is 'service overdue' or a channel warning (non-critical) then the user can continue to the next stage by pressing the right soft key 'Continue'. The BIOGAS 3000 will continue automatically after thirty seconds if continue is not pressed.

Note: If any critical faults occur, refer to section [Critical Faults](#).

Operating Manual

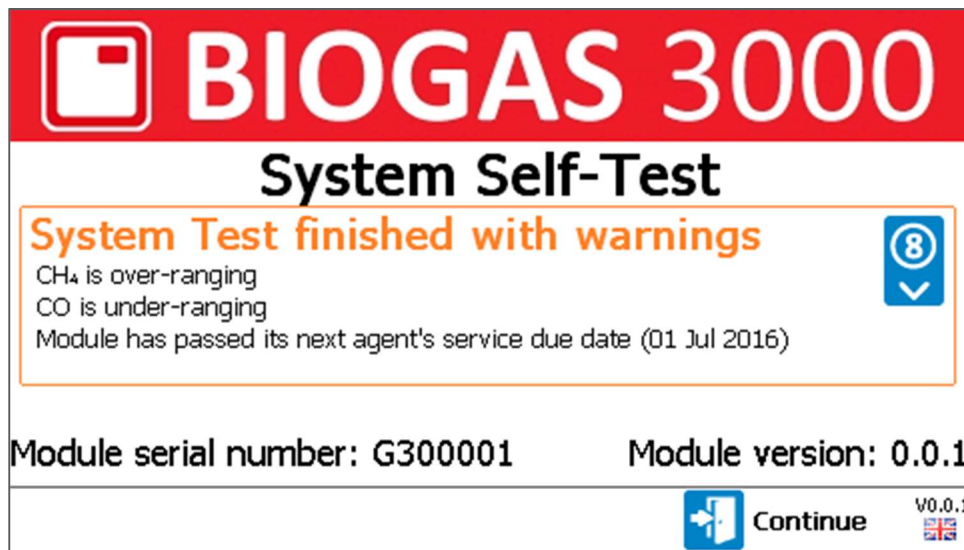

Screen 4 - Self-test finished with warnings

Help Function

In some screens, there is a help screen available. An available help screen is indicated by a '?' in the top right hand corner of the screen:

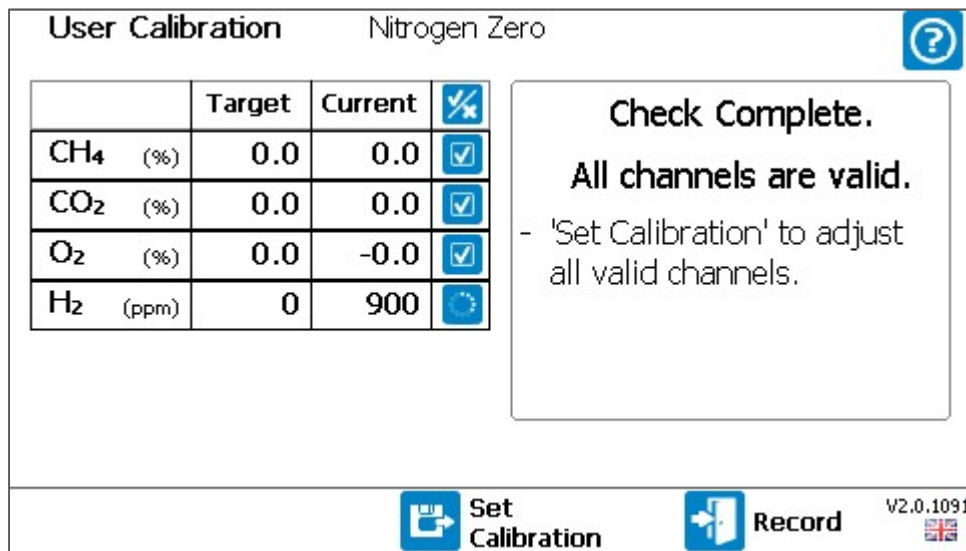

Screen 5 - Help screen available

To access the help screen, press the '?' key on the keypad. The user can scroll through pages using key the left and middle soft keys. To exit, press the right soft key.

Note: The 'Gas Readings Screen' also has a help screen but this is not identified on-screen.

## Operating Manual

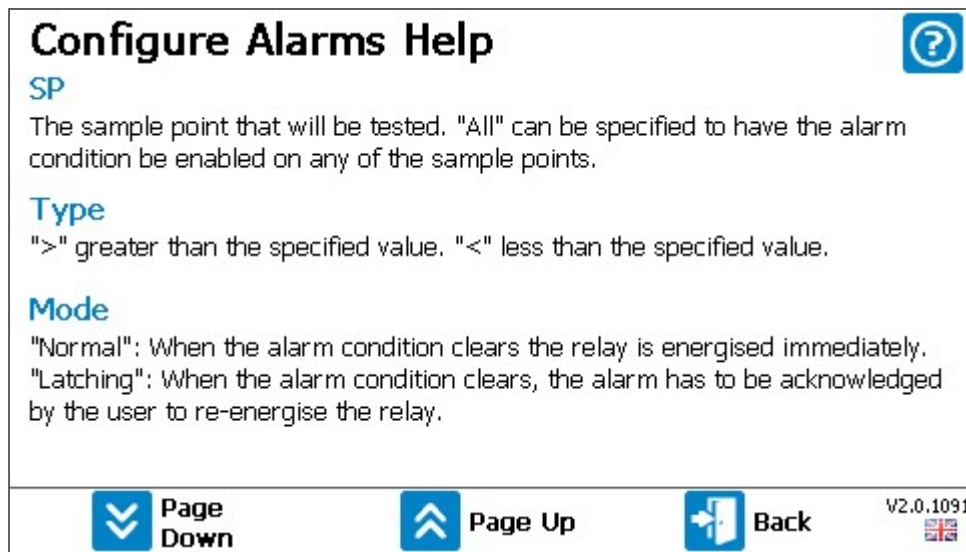

Screen 6 - Help screen example

### First Time Configuration

- 1) When switching on the module for the first time the system will detect the first time run conditions and run set-up mode. The BIOGAS 3000 is designed to be fully configurable by the end-user without QED support or configuration.

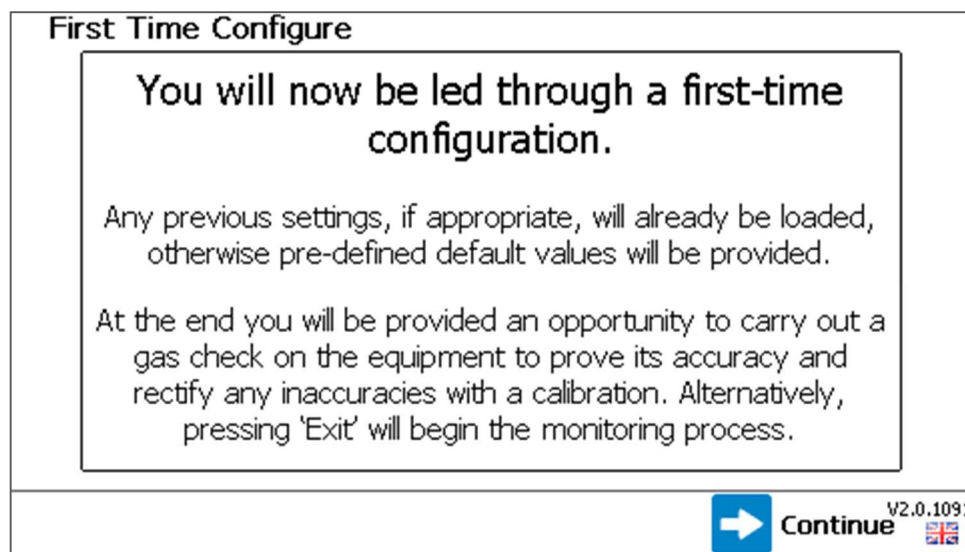

Screen 7 - First time run set-up

- 2) Press the right soft key to 'Continue'.
- 3) Set the time and date for the local time zone. For more information on how to do this, refer to section [Set Time and Date](#).
- 4) Configure the time that the daily air purge will commence. For more information on how to do this, refer to section [Daily Air Purge](#).

## Operating Manual

Note: This option will only be present on BG3KE variants.

- 5) Configure the sampling options for the various sample points. For more information on how to do this, refer to section [Sample Times](#).

Note: On a BG3KE variant without an external sensor, this option is not present.

Note: On a BG3KE variant with an external sensor, this screen will be specifically for the external sensor sampling option only as the rest of the system will measure continuously.

- 6) Customise the relay configuration. For more information on how to do this, refer to section [Configure Relays](#).
- 7) Configure alarms (if set during the relay configuration option). For more information on how to do this, refer to section [Configure Alarms](#).
- 8) Configure Modbus slave (if being used). For more information on how to do this, refer to section [Configure Modbus Slave](#).
- 9) Configure analogue outputs (if being used). For more information on how to do this, refer to section [Configure Analogue Outputs](#).
- 10) Define whether an administrator passcode is required on the system. For more information on how to do this, refer to section Admin Passcode.
- 11) Once the first time run configuration is complete, you will arrive at Screen 39 - Gas Check. To perform this, refer to section Gas Check and Calibration. To skip and begin monitoring, press the right soft key to 'Exit' (not recommended).

## Operating Manual

### Gas Readings Screen

Screen 8 - Gas readings is considered the normal operating screen and all options are carried out from this starting point:

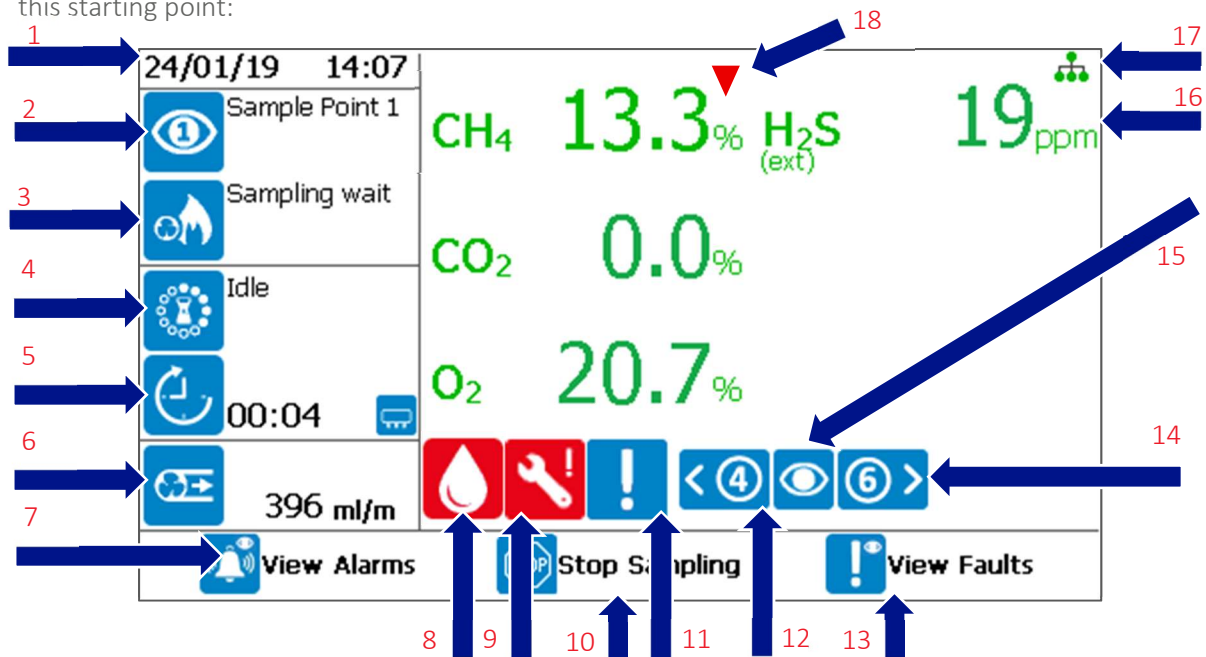

Screen 8 - Gas readings

Note: The data shown on this display will be dependent on the system variant and the option(s) that was selected at the point of sale.

#### 1. Time and date

Displays the time and date and is continuously updated.

#### 2. Sample point status

This indicates to the user the current sample point being monitored.

- |   |                |   |   |
|---|----------------|---|---|
|  | Sample point 1 |  | Sample point 4                          |
|  | Sample point 2 |  | Idle – waiting for next cycle to begin. |
|  | Sample point 3 |   |   |

## Operating Manual

### 3. Current operation

Details the current operation for the sample point and cycle:



Sampling from sample point



System air purge following sample



Idle – waiting for next cycle to begin

### 4. Operation time remaining

This is the time remaining for the current operation.



### 5. Cycle time remaining

This is the time remaining for the complete cycle. When it counts to zero, the next cycle will commence, thus starting at sample point 1 again.



### 6. Pump flow rate

This is the pump flow rate in ml/min. If this drops below 75ml/min, the reading will have an amber background and the system will flow fail and stop sampling after fifteen seconds – see [Low Flow / Flow Fail](#) for more information.



### 7. View alarms

Accessed using the left soft key, it takes the user to the alarm summary screen. See [Alarms](#) section.



## Operating Manual

### 8. Catchpot full icon

Indicates to the user that there is liquid in the catchpot and it needs emptying.



### 9. Service icon

An indication to the user that the module is due a service. See [Service](#) section.



### 10. Stop sampling

Press the middle soft key to stop the sample process and freeze the outputs at their last known value. This can be useful when maintenance on site may be required. See [Stop Sampling](#) section.



### 11. Non-critical fault warning

This icon displays when there is a non-critical fault present on the system. A non-critical fault is a fault that will not stop the system from functioning. See [Fault](#) Detection for more information.



### 12. Scroll left

Use key '4' to scroll through the previously stored gas readings. This will display the readings in memory for the data being output for the particular sample point shown.



### 13. View faults

Press the right soft key to view the faults summary screen.





## Operating Manual

### 14. Scroll right

Use key '6' to scroll through previously stored gas readings. This will display the readings in memory for the data being output for the particular sample point shown.



### 15. Current view

Indicates which sample point the data on screen is representing with a number in the eye. These icons are the same as the sample point status icons. An eye without a number represents live readings for the current sample point being monitored.

### 16. Gas readings

Displays the readings for the gases available. Green text indicates the reading is live. Blue text indicates the reading is a stored reading against the sample point. If the gas channel is an external cell, "(external)" will be shown below the gas name.

### 17. Internet connectivity status

Displays the current status of the internet server connection, by means of a colour-coded symbol.

Icon	Colour	Definition
	Green	Successful connection to the server
	Green / Yellow	Attempting to connect to the server
	Blue	Local connection only, not connected to the server
	Amber	Internet connection problem
	Grey	Idle, connection not attempted

### 18. Hydrocarbon adjustment

The red triangle icon ( ▼ ) above the CH<sub>4</sub> reading indicates that the value displayed has been adjusted using the Hydrocarbon adjustment option. See also [Hydrocarbon Adjustment](#).

## Operating Manual

### Alarms

### Notification

Note: For information on how to set alarms, please refer to section [Configure Alarms](#).

When an alarm condition has been met, the alarming channel will become highlighted with a bell icon and the 'View Alarm' soft key becomes red. An example screen is shown on the next page of a channel with an active alarm.

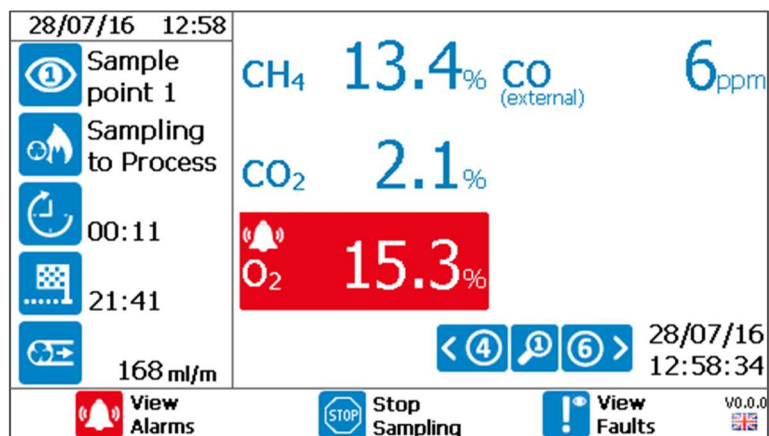

Screen 9 - Alarm notification

The following notifications are available on the BIOGAS 3000:

Icon	Definition
	The alarm is active and the associated relay has been de-energised.
	The alarm is active but the channel is within its recovery zone. The associated relay remains de-energised until the recovery value is met.
	This is the latched alarm indicator. This indicates a channel has alarmed and recovered. During this notification, the relay remains de-energised until the alarm notification has been acknowledged by the operator.
	The alarm has been silenced by the operator and the associated relay is energised. The alarm condition on the system remains active in the background until the recovery condition is met.

### Viewing Alarms

To view an alarm, from the 'Gas Readings Screen' press the left soft key to go to [Screen 10 - Alarms summary](#):

## Operating Manual

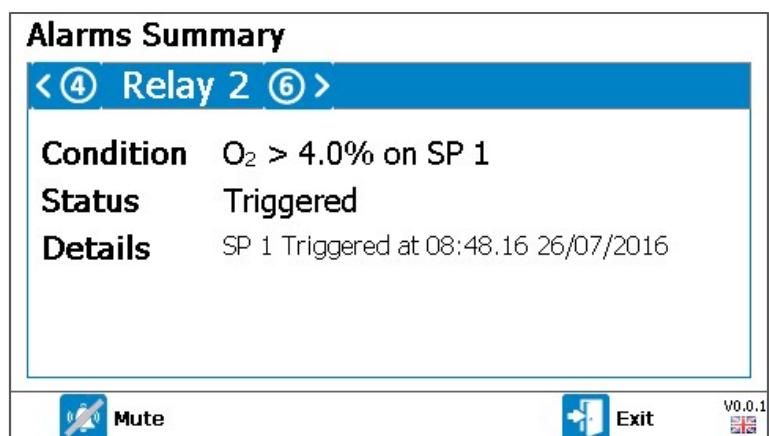

Screen 10 - Alarms summary

This screen will detail all alarm conditions set by the operator. It will detail the condition for the alarm to trigger, the status (inactive, triggered, latched, or recovering), the time and date of the alarm, and the associated relay.

Pressing key '4' and key '6' scrolls the user through the relays available for alarms. This will also summarise inactive alarms.

Pressing the left soft key ('Mute') on an active alarm will disable the alarm and re-energises the associated relay until the condition is cleared.

Pressing the left soft key ('Clear Latch') on a latched alarm will unlatch the alarm, clearing its status and re-energises the associated relay.

Operating Manual

Stop Sampling

From the 'Gas Readings Screen', pressing the middle soft key will 'Stop Sampling'. At this point, the sampling process is stopped, all solenoid valves are closed, and the outputs are frozen at their last known value. The following screen will be presented to the user:

Output	SP	Gas	Reading	mA
1	1	CO2	0.0	4.0
2	All	O2	5.5	7.5
3		(Disabled)		
4		(Disabled)		
5		(Disabled)		
6		(Disabled)		

Screen 11 - Sampling Stopped

Pressing the left soft key will 'Restart' the sampling process and return the user to the 'Gas Readings Screen'.

**Note:** When resuming the sampling process, all active alarms will become inactive until retriggered as part of the process.

Pressing the middle soft key will fix the outputs to the pre-determined safe values. These are shown in the table onscreen.

Pressing the right soft key allows the user to edit the safe values. For more information on this, please see [Configure Analogue Outputs](#).

## Operating Manual

### Menu

The menu enables the operator to select options to set-up specific parameters and perform operational tasks.

The menu is divided in to three areas:

- 1) Settings – this menu appears from the ‘Gas Readings Screen’ when pressing the ‘Menu’ key
- 2) Calibration – this menu is accessed from either the ‘Settings’ menu or the ‘Device Info’ menu by pressing the middle soft key
- 3) Device Info – the device information menu is accessed from either the ‘Settings’ menu by pressing the left soft key.

### Settings Menu

Depending on the option chosen at manufacture, the following options are available from the settings menu:

- 1) Sample Times

**Note:** On a BG3KE with an external cell, this option will be for the external cell sample options as the rest of the system runs continuously.

On a BG3KE without an external cell, this option will be the daily air purge.

- 2) Configure Alarms
- 3) Configure Interface
- 4) Adjust Backlight
- 5) Set Time and Date
- 6) Admin Passcode
- 7) Daily Air Purge

**Note:** This option is only available on BG3KE variants.

- 8) Set Language

An example of the ‘Settings’ menu is shown on the next page.

## Operating Manual

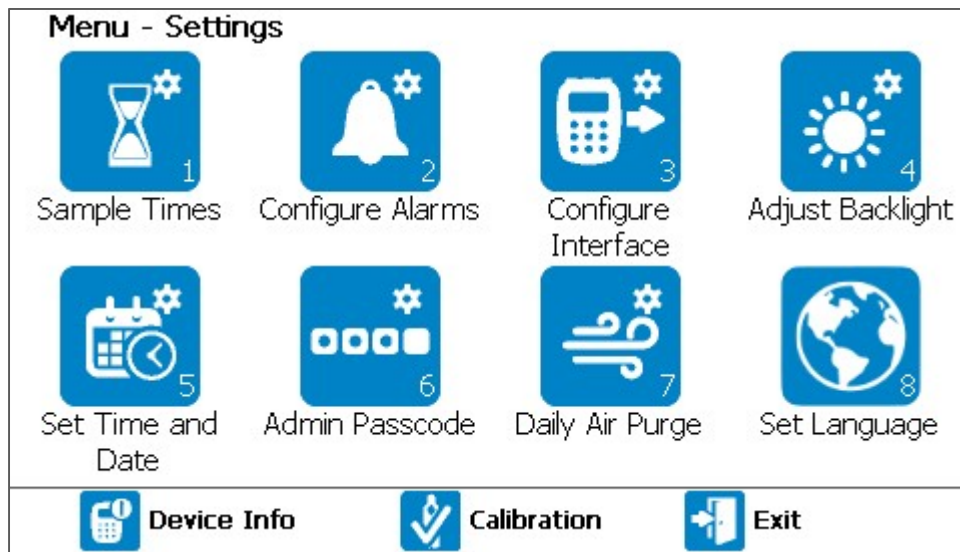

Screen 12 - Settings Menu

Following a change to 'Sample Times', 'Configure Interface', or 'Daily Air Purge', when returning to the 'Gas Readings Screen', the system will apply the new configuration once 'Confirm' is pressed using the left soft key.

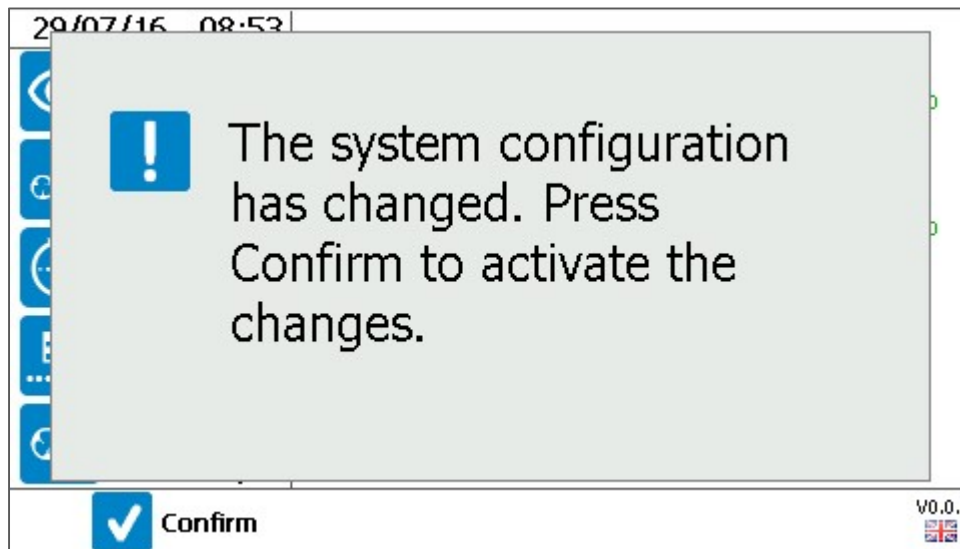

Screen 13 - Confirm new configuration



## Operating Manual

### Sample Times

This option allows the operator to define the duration of each sample point (or the external sensor if the system is a BG3KE).



- 1) From the 'Settings' menu press key '1' to select the 'Sample Times' option. A summary screen will be shown.

Configure Sample Times		
SP	Duration	Air Purge
1	11:00	00:03:00
2	01:30	00:03:00
3	01:30	00:03:00
4	01:30	00:03:00
Total	00:27:30	
Cycle	00:46:30	

 Edit
 Exit
V0.0.0 

Screen 14 - Configure Sample Times (Non-E variant)

Configure Sample Times		
SP	Duration	Air Purge
External Cell	01:30	00:03:00
Total	00:04:30	
Sample	00:30:00	

 Edit
 Exit
V0.0.1 

Screen 15 - Configure Sample Times (E variant)

- 2) Press the right soft key to 'Exit' without saving any changes.
- 3) To edit a parameter, press the middle soft key to enter 'Edit' mode.
- 4) Using the scroll keys, select a sample point to edit (highlighted in the table) and select the field with the  $\leftarrow$  key.

## Operating Manual

Note: In addition to each sample point being editable, the 'Sample' time is also an editable parameter. This is the total time of the cycle before sample point 1 (or external cell) is monitored again.

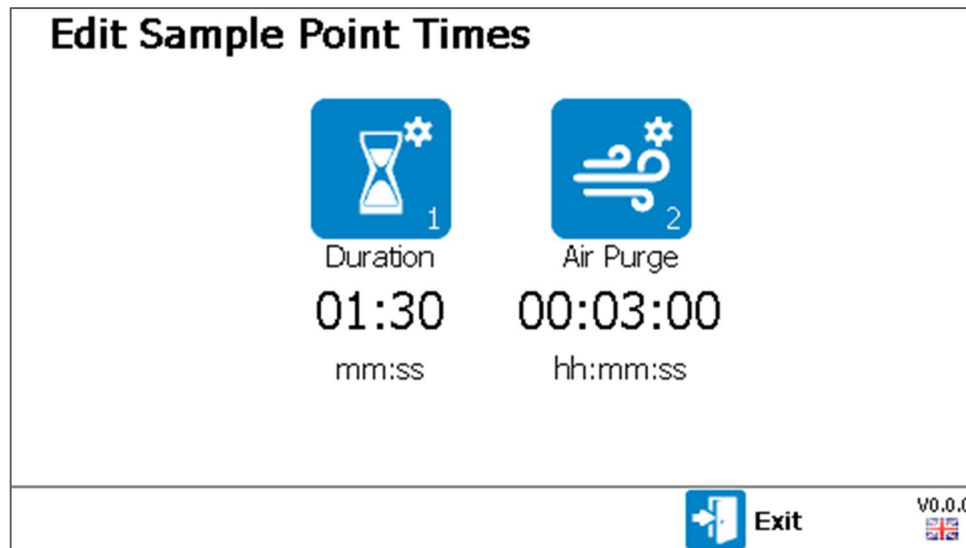

Screen 16 - Edit Sample Point Times

- 5) Press key '1' to edit the sample duration or key '2' to edit the air purge duration.
- 6) Key in a suitable time for the system and store using the  $\leftarrow$  key.

Note: Both parameters have minimum and maximum values that can be entered. If a time is outside of this range, the user will be prompted to enter a more suitable time.

- 7) Once a parameter has been changed, the left soft key becomes available to 'Save and Exit'. Once pressed, the user will be returned to the summary screen.

Note: If changing a duration exceeds the 'Sample' time, the 'Sample' time will automatically be updated to accommodate the change.

- 8) Press the right soft key to 'Exit' back to the 'Settings' menu.

### Configure Alarms

This option allows the operator to define alarm conditions for a gas on any given sample point.

The relays operate in fail-safe mode. This means the relay is normally energised. When an alarm condition is met, the relay de-energises.



Note: The quantity of available alarms will be dependent on the relay configuration, see [Configure Relays](#) section. The relay configuration should be determined before configuring the alarms.



## Operating Manual

- 1) From the 'Settings' menu press key '2' to select the 'Configure Alarms' option.

Configure Alarms						
Relay	Channel	SP	Type	Mode	Value	Recovery
1	CH4	1	>	Normal	60.0	50.0
2	O2	1	>	Normal	4.0	0.0
3		1	Disabled	Normal	0.0	0.0
4		1	Disabled	Normal	0.0	0.0
6		1	Disabled	Normal	0.0	0.0

 **Edit**
 **Exit**
V0.0.1  

Screen 17 - Configure Alarms

- 2) Press the right soft key to 'Exit' without saving any changes.
- 3) To 'Edit' a parameter, press the middle soft key to enter edit mode. Using the scroll keys, select a parameter to edit (highlighted in the table) and select the field with the  $\leftarrow$  key.

### Definitions

Term	Definition
SP	The sample point (1, 2, 3, 4, or All) for which the alarm condition is to be monitored.
>	Alarm to trigger above the value.
<	Alarm to trigger below the value.
Disabled	Alarm is disabled and will not activate.
Normal	When an alarm has occurred and the gas concentration reaches its recovery value, the alarm will deactivate.
Latched	When an alarm has occurred and the gas concentration reaches its recovery value, the alarm will remain activate until cleared by the operator.
Value	The gas concentration for which the alarm condition will become active.
Recovery	The gas concentration for which the alarm condition will recover.

- 4) Use the scroll keys to select the chosen parameter and select using the  $\leftarrow$  key, or use the keypad to enter the gas concentration for the value followed by the  $\leftarrow$  key to confirm.

## Operating Manual

- 5) Once a parameter has been changed, the left soft key becomes available to 'Save and Exit'. Once pressed, the user will be returned to the 'Settings' menu.

Note: Alarm settings become active immediately.

Note: When any alarm setting is updated all active alarms will reset.

### Configure Interface

This option allows the operator to configure the various interface options with the system to the client's side. There are three options in this sub-menu:

- 1) Configure Analogue Outputs
- 2) Configure Modbus Slave
- 3) Configure Relays

To 'Exit' this screen, press the right soft key to return to the 'Settings' menu.

#### Configure Analogue Outputs

This option allows the user to configure the six 4-20mA analogue outputs. The user can define a gas on any given sample point and set the safe-value that is output should the customer select this option via the [Stop Sampling](#) feature.

Note: The safe value is a gas concentration that will force the 4-20mA and Modbus registers to pre-fixed values. This is to prevent erroneous errors or alarm conditions in the user's remote system whilst maintenance is being performed on the BIOGAS 3000 or any other plant equipment.

- 1) From the 'Configure Interface' menu press key '1' to select the 'Configure Analogue Outputs' option.

Configure Analogue Outputs <span style="float: right;">?</span>				
Output	Sample Point	Gas	Safe Value	mA
1	1	CH4	55.0	12.8
2	1	CO2	40.0	10.4
3	1	O2	0.0	0.0
4	Disabled		0.0	0.0
5	Disabled		0.0	0.0
6	Disabled		0.0	0.0

Edit
 Exit
V0.0.1

Screen 18 - Configure Analogue Outputs

## Operating Manual

- 2) Press the right soft key to 'Exit' without saving any changes.

**Note:** The safe value is a gas concentration that will force the 4-20mA and Modbus registers to pre-fix. If the user has accessed the 'Configure Analogue Outputs' screen via the 'Stop Sampling' screen, the user will be returned to the 'Stop Sampling' screen.

- 3) To 'Edit' a parameter, press the middle soft key to enter edit mode. Using the scroll keys, select a parameter to edit (highlighted in the table) and select the field with the  $\leftarrow$  key.
- 4) Use the scroll keys to select the chosen parameter and select using the  $\leftarrow$  key, or use the keypad to enter the gas concentration for the safe value followed by the  $\leftarrow$  key to confirm.
- 5) Once a parameter has been changed, the left soft key becomes available to 'Save and Exit'. Once pressed, the user will be returned to the 'Configure Interface' menu.

### Configure Modbus Slave

This option allows the user to configure the Modbus digital output of the BIOGAS 3000. The user can change the following parameters:

- Slave Address – this is the address of the BIOGAS 3000 on the bus
  - Baud Rate – Information is transferred in a communication channel at this rate. Modbus is typically 9600 or 19200
  - Data Bits – the number of bits used to represent one character of data. This parameter cannot be changed
  - Parity – the parity bit is used as a simple error detection algorithm. Setting parity to odd will result in an odd number of 1 bits
  - Stop Bits – this is the number of bits to identify the end of a byte. This is typically set to 1
  - Termination – this is used to enable/disable the termination resistor within the system. This is typically enabled for systems that are the first or last connection on the bus.
- 1) From the 'Configure Interface' menu press key '2' to select 'Configure Modbus Slave' option.

## Operating Manual

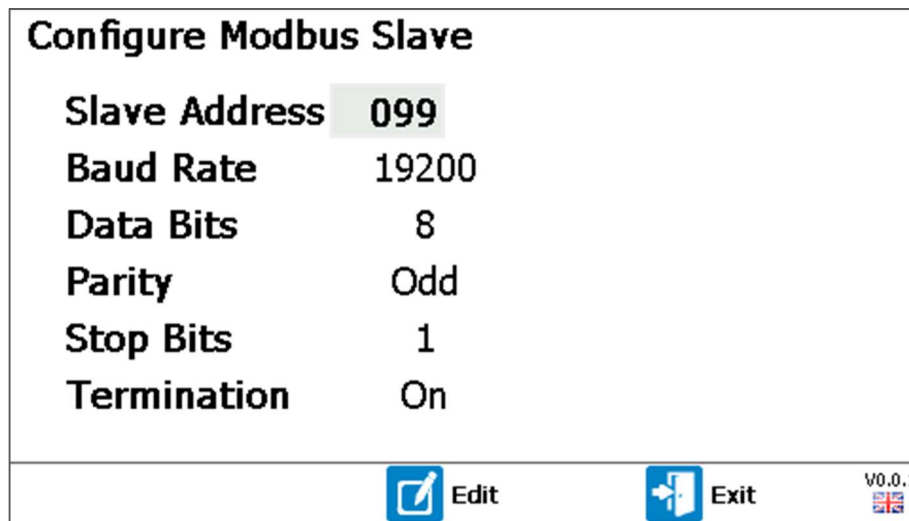

Screen 19 - Configure Modbus Slave

- 2) Press the right soft key to 'Exit' without saving any changes.
- 3) To 'Edit' a parameter, press the middle soft key to enter edit mode. Using the scroll keys, select a parameter to edit (option will be highlighted) and select the field with the  $\leftarrow$  key.
- 4) Use the scroll keys to select the chosen parameter and select using the  $\leftarrow$  key, or use the keypad to enter the numeric required followed by the  $\leftarrow$  key to confirm.
- 5) Once a parameter has been changed, the left soft key becomes available to 'Save and Exit'. Once pressed, the user will be returned to the 'Configure Interface' menu.

### Configure Relays

This option allows the user to configure the eight relays in the system. 'Relay 8' is the fault relay and cannot be changed.

- 1) From the 'Configure Interface' menu press key '3' to select the 'Configure Relays' option.

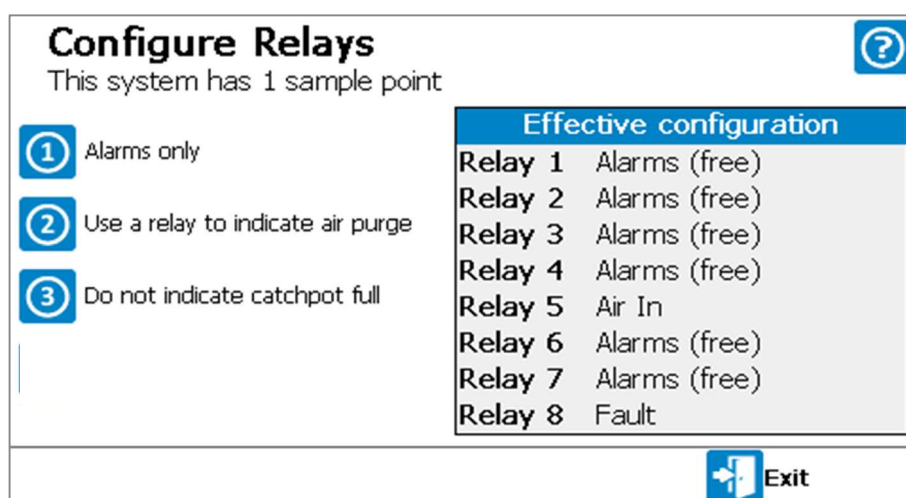

Screen 20 - Configure Relays

## Operating Manual

- 2) Press the right soft key to 'Exit' without saving any changes.
- 3) Press key '1' to change the 'Mode' of the relays. Available options are:
  - Alarms only – Relays are only used to indicate an alarm status (refer to [Configure Alarms](#) for information on how to define alarm settings)
  - Indicate 4-20mA outputs sample point – This mode enables a relay for when the 4-20mA signal is valid for a given sample point. This is useful if a 4-20mA output is being used to obtain the gas reading for a single gas channel across all sample points

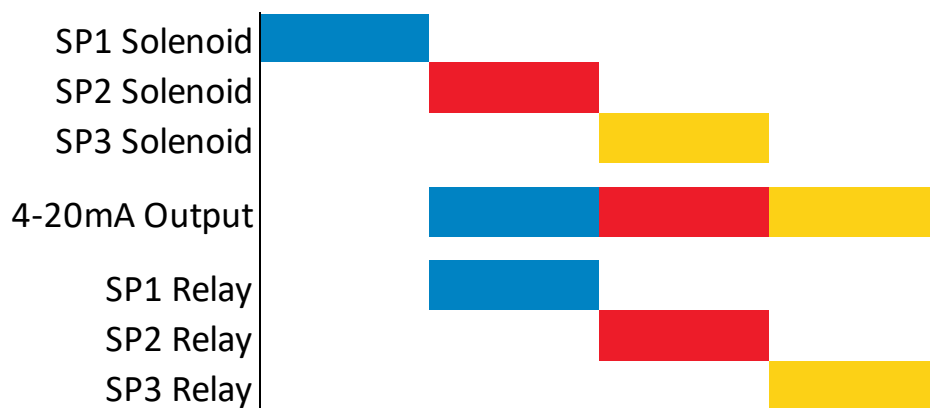

Figure 12 - 4-20mA notification

- Indicates current sample point solenoid – This mode enables a relay for when a sample point is being monitored. This is useful if the operator needs to know when a sample point is being monitored

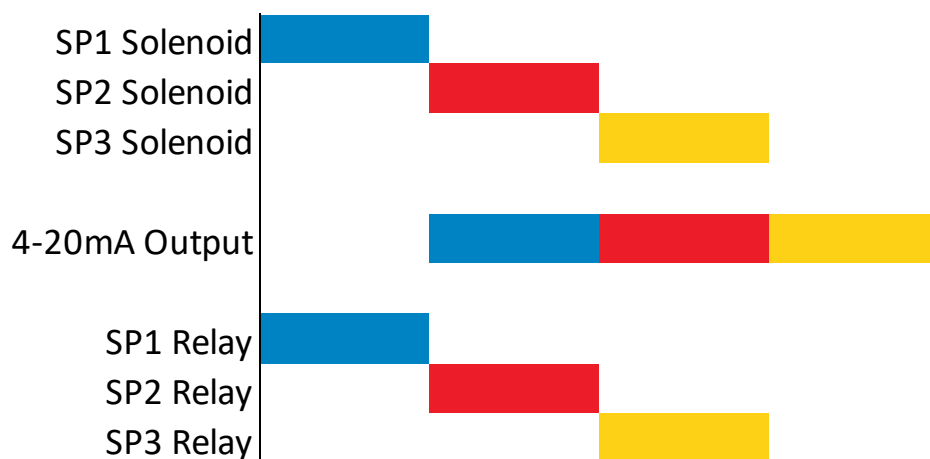

Figure 13 - Sample point notification

Note: When enabling the relays for 4-20mA or sample point notification, the remaining available relays will automatically be defaulted to 'Alarms'.

- 4) Press key '2' to define whether a relay is used to indicate when an air purge is occurring. If this option is selected, this will automatically be defaulted to 'Relay 5'.

## Operating Manual

- 5) Press key '3' to define whether a relay is used to indicate when the catchpot contains liquid and needs emptying. If this option is selected, this will automatically be defaulted to 'Relay 7'.

**Note: If the system was fitted with the auto-drain option at point of manufacture, this option will not be available in the 'Configure Relays' screen.**

- 6) Once a parameter has been changed, the left soft key becomes available to 'Save and Exit'. Once pressed, the user will be returned to the 'Configure Interface' menu.

### Configure Ethernet

This option allows the user to configure the Internet Connectivity, to enables the user to access the system remotely using an online cloud-based portal. The benefits of this include remote access to:

- View live gas readings and sensor readings
- View live system status
- Perform air calibration
- Stop and restart the sampling process
- Restart the system
- View system settings
- View event log data
- Update the firmware
- Requesting remote technical support

**Note: A network firewall exception for port 6470 will be required to allow authorised access.**

The user can change the following parameters:

- Auto-DHCP
- Auto-connection
- IP address
- Subnet mask
- Gateway
- DNS Server

## Operating Manual

- 1) From the 'Configure Interface' menu press key " to select the 'Configure Ethernet' option.

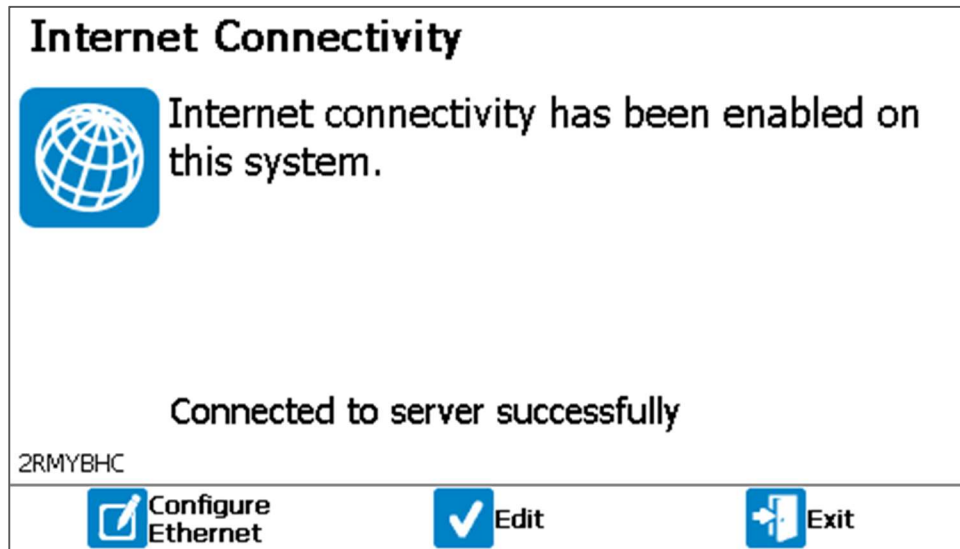

Screen 21 – Configure Ethernet, Internet Connectivity

- 2) Pressing the right soft key exits to the 'Configure Interface' screen, and pressing the left soft key 'Configure Ethernet' allows the user to manually change settings. Press the middle soft key option 'Edit' to enable Internet Connectivity.

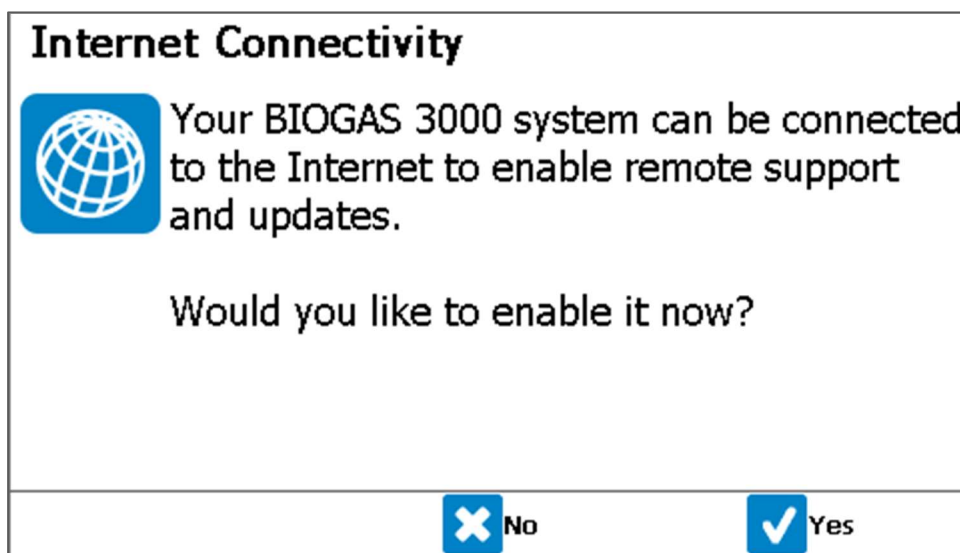

Screen 22- Configure Ethernet, enable connection

- 3) Press middle soft key 'No' to return to the Configure Interface screen, or press right soft key 'Yes' to enable internet connectivity.

## Operating Manual

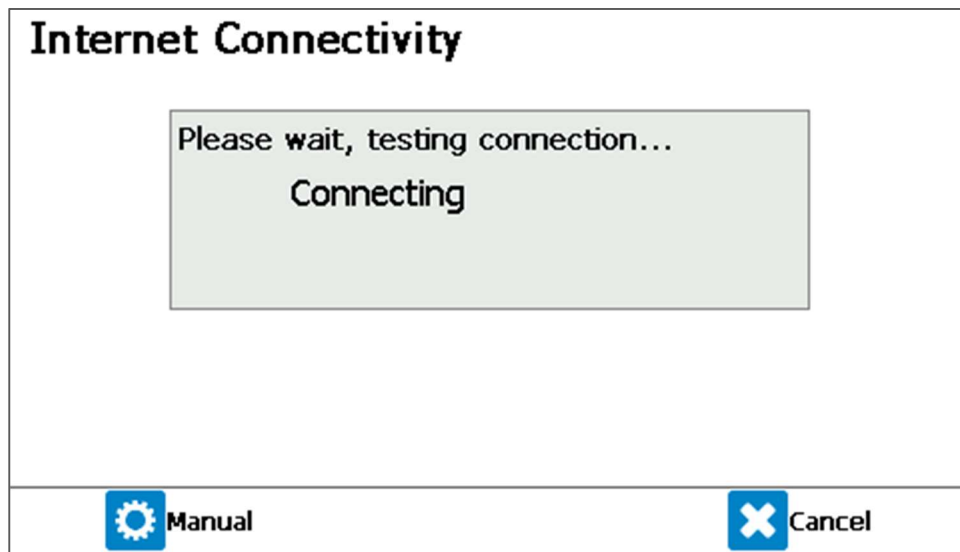

Screen 23 - Configure Ethernet, connection test

- 4) The system will now attempt to connect to the server. This test should take less than 1 minute.

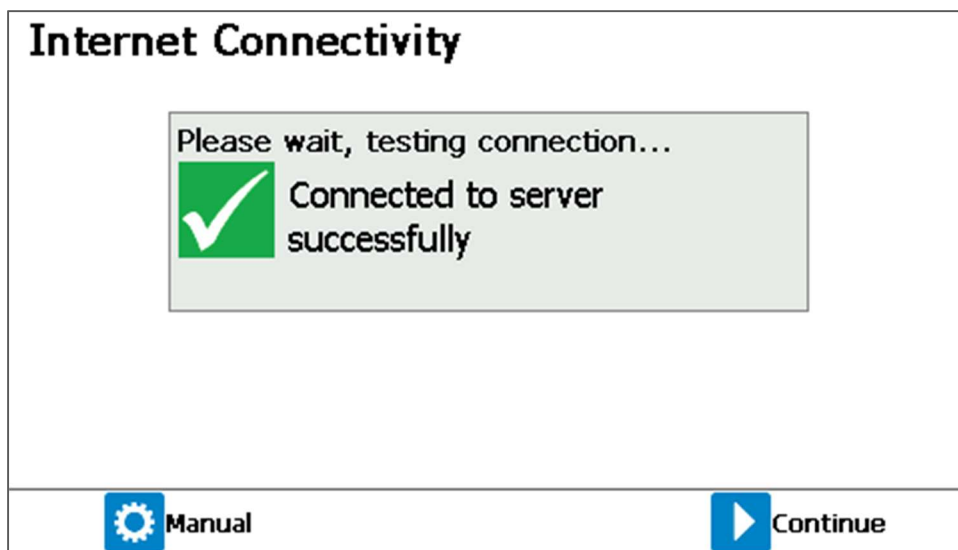

Screen 24 - Configure Ethernet, connected successfully

- 5) A message will indicate the status of the connection. If unsuccessful, use the left soft key to manually edit the Ethernet settings, or the right soft key to return to the 'Configure Interface' menu. If successful, press the right soft key option 'Continue' to proceed to the security code screen.



## Operating Manual

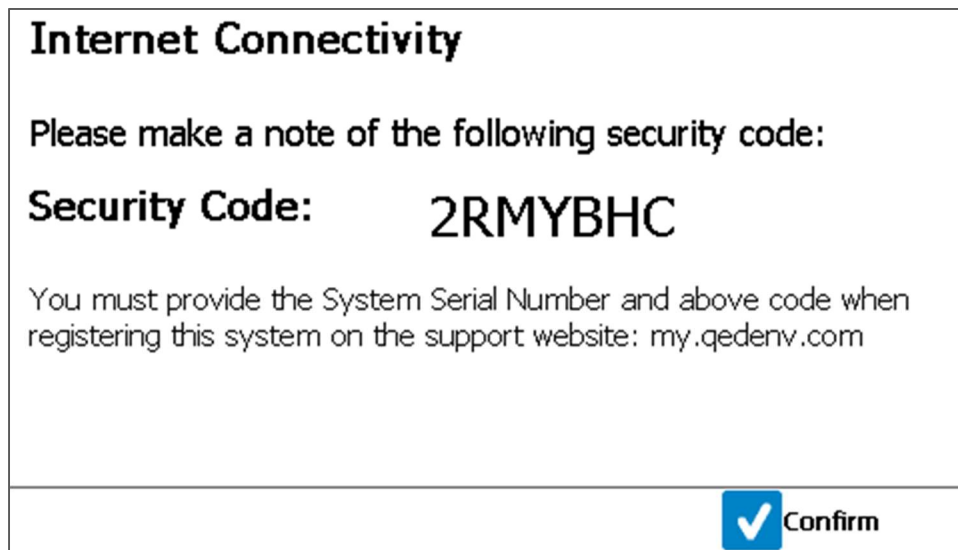

Screen 25 - Configure Ethernet, Security Code

- 6) The displayed 'Security Code' is unique to your system. Use this code together with your system serial number (e.g. BG3K1234) to register your system on the 'QED Customer Portal' at <https://my.qedenv.com> to gain the benefits of Internet connectivity.

This security code is also displayed in the bottom left of on the Internet Connectivity [Screen 21](#).

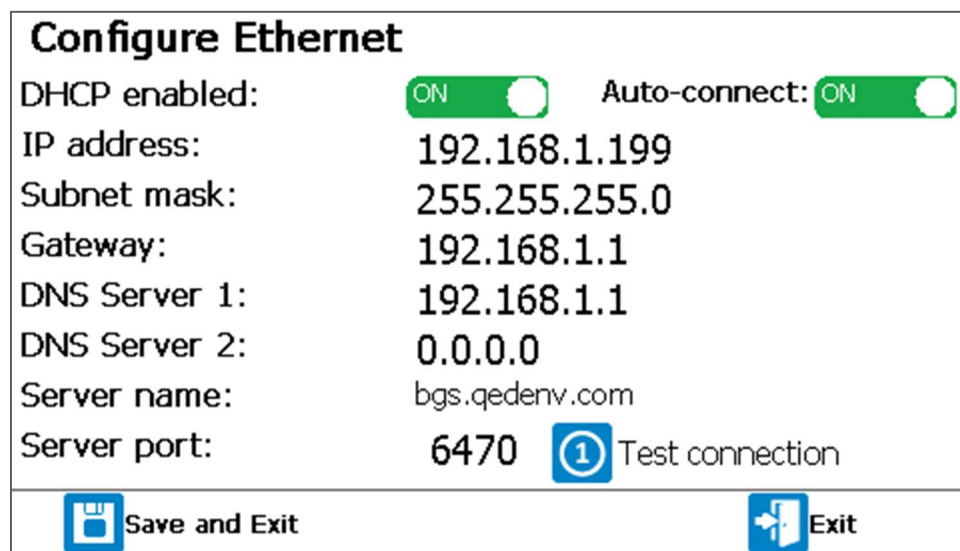

Screen 26 – Configure Ethernet, manual configuration

- 7) Manually configure the Ethernet settings by pressing the left soft key 'Configure Ethernet' on the main 'Internet Connectivity' screen or left soft key 'Manual' after a failed connection attempt.
- 8) Press middle soft key 'Edit'. Toggle the 'DHCP enabled' and 'Auto-connect' options using the enter '↵' key. Use the arrow keys to navigate to the other options and press enter '↵' to edit. Use the number keys to enter new addresses and enter '↵' to save. Use the middle soft key

## Operating Manual

'Delete' to backspace, or press right soft key 'Cancel' during editing to discard any changes made to that field.

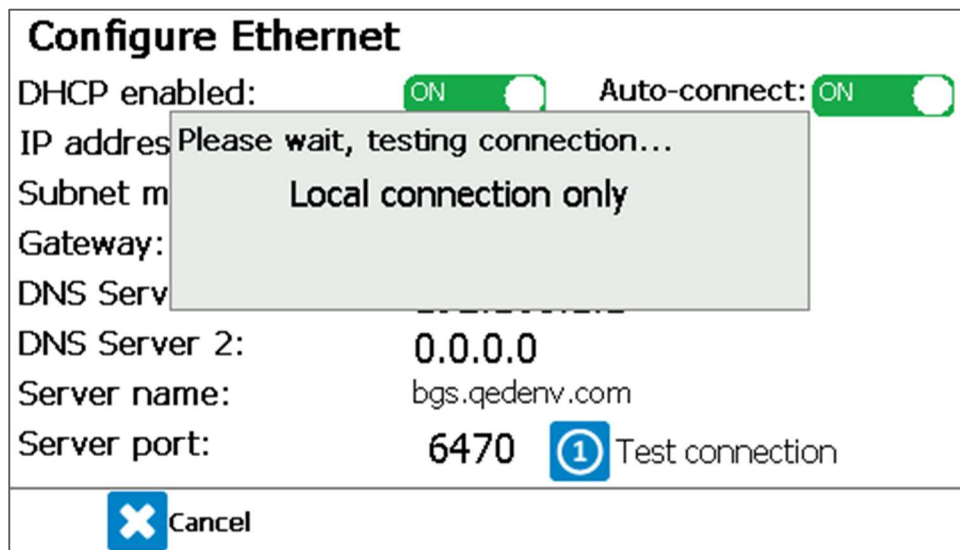

Screen 27 - Configure Ethernet, manual connection test

- 9) Press key '1' to 'Test connection' settings. Use left soft key 'Cancel' to exit a failed attempt.
- 10) Press left soft key 'Save and Exit' to save changes and reattempt internet connection.
- 11) An icon in the top right of the main gas reading screen indicates internet connection status, see also [Internet connectivity status](#).

## Operating Manual

### Adjust Backlight

This option allows the operator to set the brightness of the backlight and the timer for when it will auto dim. In addition, the backlight can also be controlled using the 'backlight' key at any time. Having a brighter backlight will improve the readability of the display in bright sunlight.

- 1) From the 'Settings' menu press key '4' to select the 'Adjust Backlight' option.

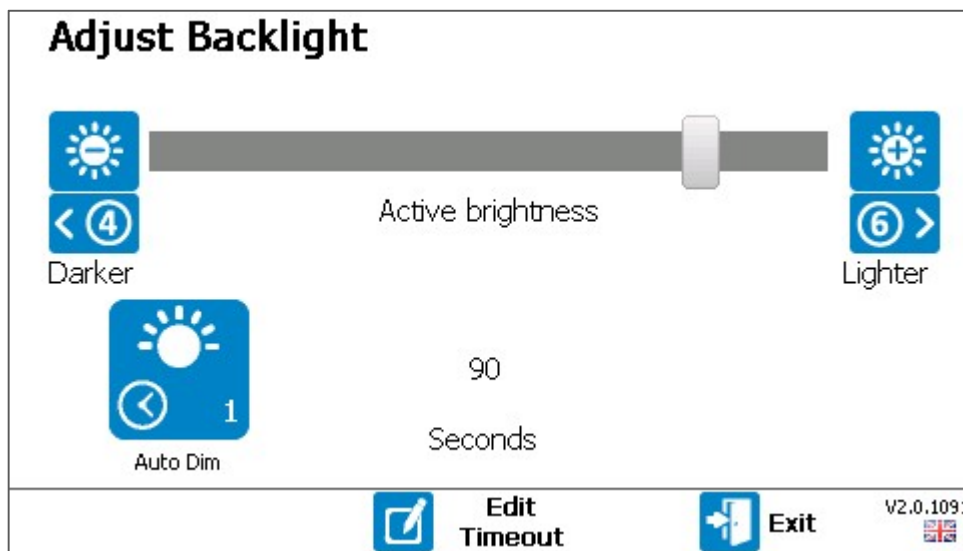

Screen 28 - Adjust Backlight

- 2) Press the right soft key to 'Exit' without saving any changes.
- 3) Press key '6' to increase the brightness of the display or use key '4' to reduce the brightness.
- 4) Press key '1' to set whether the backlight auto-dims after a timeout or is always on and controlled manually by the 'Backlight' key.
- 5) If 'Auto Dim' is enabled, press the middle soft key to edit the auto dim timeout. Use the keypad to enter a value and store using the ↵ key.
- 6) Once the settings have been changed, the left soft key becomes available to 'Save and Exit'. Once pressed, the user will be returned to the 'Configure Interface' menu.

### Set Time and Date

This option allows the user to set the time and date on the system. The time and date is recorded alongside the reading taken for each sample point.

- 1) From the 'Settings' menu press key '5' to select the 'Set Time and Date' option.

## Operating Manual

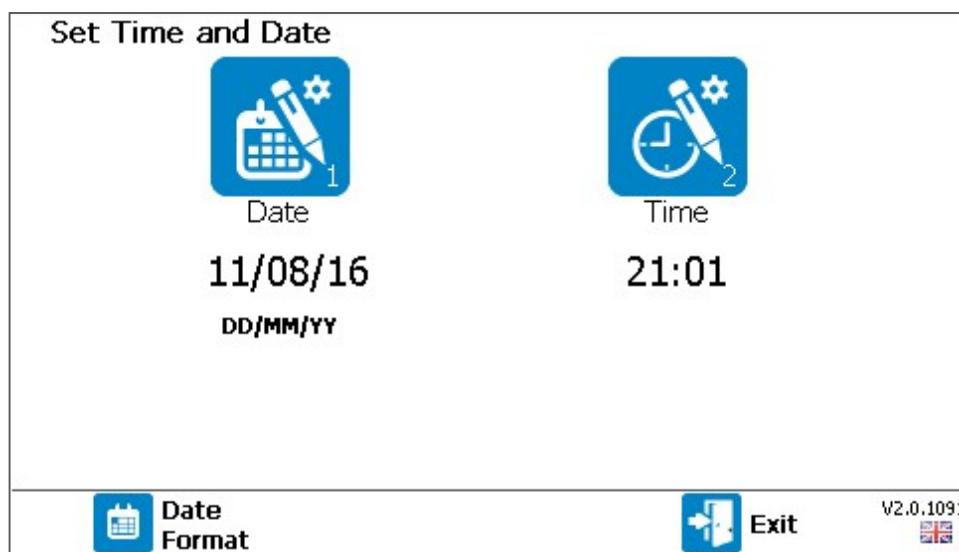

Screen 29 - Set Time and Date

- 2) Press the right soft key to 'Exit' without saving any changes.
- 3) Press the left soft key to toggle the date format. Available options are DD/MM/YY, MM/DD/YY, and YY/MM/DD.
- 4) Press key '1' to edit the date or key '2' to edit the time.
- 5) Key in a suitable date or time for the system and store using the  $\leftarrow$  key.

**Note: Invalid time or date entries will not be accepted.**

- 6) Once the setting has been changed, it is stored immediately.

**Note: At this point, the new setting is written to the Interface PCB. If this is not successful, an error message is displayed and the setting will need to be entered again.**

- 7) Press the right soft key to 'Exit'. Once pressed, the user will be returned to the 'Settings' menu.

### Admin Passcode

The administrator passcode protects against unauthorised changes to the system's set-up. The following screens are passcode protected:

- Sample Times
- Daily Air Purge (if enabled)
- Configure Alarms
- Configure Analogue Outputs
- Configure Modbus Slave
- Configure Relays

## Operating Manual

- Configure Ethernet
- Admin Passcode
- Calibration menu

1) From the 'Settings' menu press key '6' to select the 'Admin Passcode' option.

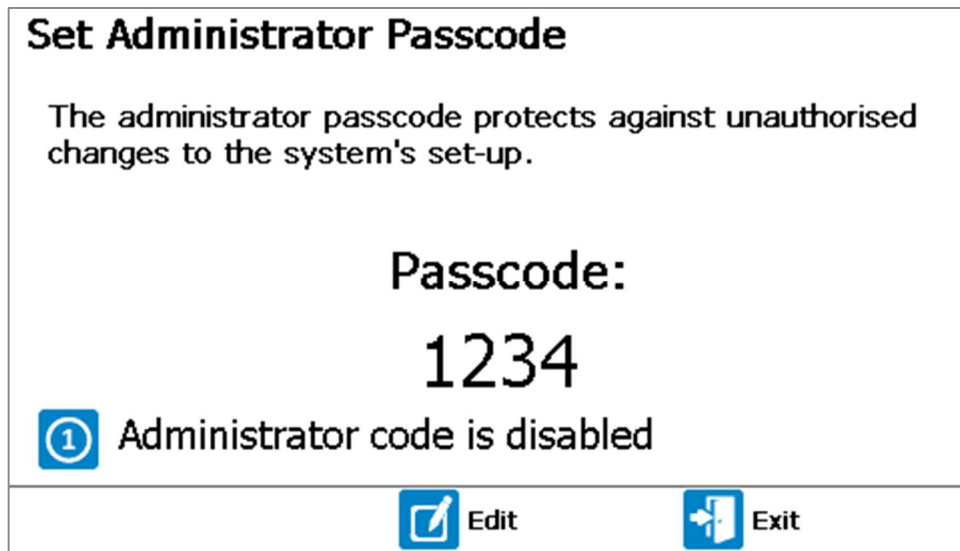

*Screen 30 - Set Administrator Passcode*

- 2) Press the right soft key to 'Exit' without saving any changes.
- 3) Press key '1' to enable or disable the administrator passcode.
- 4) To 'Edit' the current passcode, press the middle soft key to enter edit mode. Using the keypad, enter a four-digit passcode and press the **↵** key to commit the passcode.
- 5) Once committed, the right soft key becomes available to 'Save and Exit'. Once pressed, the user will be returned to the 'Settings' menu.
- 6) Alternatively, the operator can press the left soft key to 'Cancel' their changes. This option will also return the user to the 'Settings' menu.

### Administrator Passcode Required Prompt

When trying to edit a parameter that is passcode protected, the user will be prompted with [Screen 31 - Administrator Passcode Required prompt](#).

Operating Manual

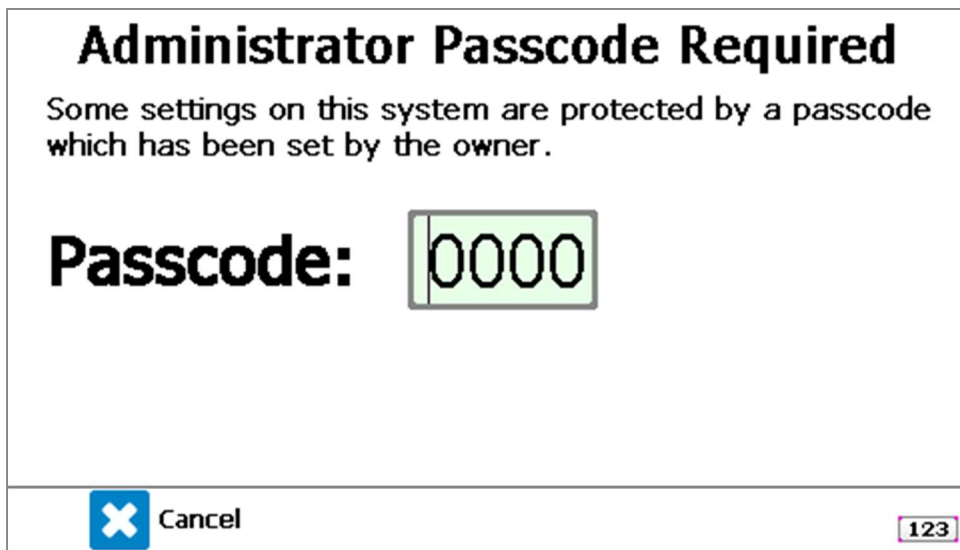

Screen 31 - Administrator Passcode Required prompt

For the user to edit the setting, they must enter the correct passcode followed by the  $\leftarrow$  key. Once the passcode has been entered once, it will not need entering again whilst remaining in the menus.

Once the user has returned to the 'Gas Readings Screen', any further changes to the passcode-protected settings will require the administrator passcode to be entered again.

**Daily Air Purge**

This screen allows the operator to define the settings for the daily air purge. The daily air purge is only available on the continuous BG3KE variants to prolong the life of the O<sub>2</sub> sensor. All other variants receive an air purge after each sample point is monitored.

- 1) From the 'Settings' menu press key '7' to select the 'Daily Air Purge' option.

Note: For a BG3KE without an external sensor, the daily air purge will be option '1' in the 'Settings' menu.

## Operating Manual

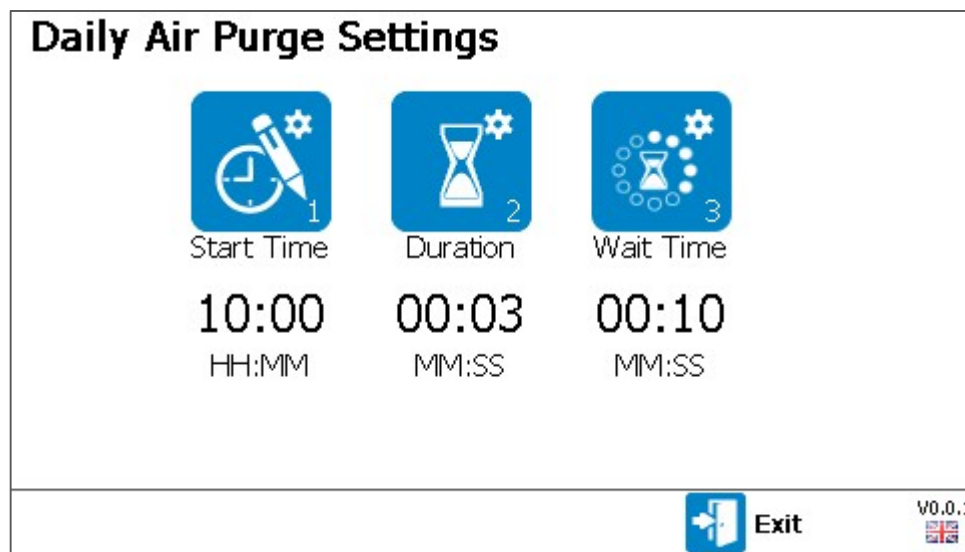

Screen 32 - Daily Air Purge settings

- 2) Press the right soft key to 'Exit' without saving any changes.
- 3) Press key '1' to edit the start time, key '2' to edit the air purge duration, or key '3' to edit the wait time.

**Note:** The 'Wait Time' is the time the system waits before updating the outputs when sampling is recommenced after a daily air purge, gas check, calibration, or stopping the sampling process. It is important that a suitable time be entered to ensure the system readings have stabilised to avoid false alarms.

**Note:** All parameters have minimum and maximum values that can be entered. If a time is outside of this range, the user will be prompted to enter a more suitable time.

- 4) Key in a suitable time for the system and store using the ↵ key.
- 5) Once a parameter has been changed, the left soft key becomes available to 'Save and Exit'. Once pressed, the user will be returned to the 'Settings' menu.

### Set Language

This screen allows the operator to define the language setting for the module. Currently, there are seven supported languages; English, Spanish, German, French, Italian, Polish and Chinese.

## Operating Manual

- 1) From the 'Settings' menu press key '8' to select the 'Set Language' option.



Screen 33 – Set Language

- 2) Press the right soft key to 'Exit' without saving any changes.
- 3) Press the number on the flag for the language you would like to select.

Note: Once selected, a prompt in the selected language will pop-up advising the user to 'please wait'.

- 4) Once the language is applied, the user will be returned to the 'Settings Menu'.

### Device Information Menu

The device information menu contains information relating to the system. The following options are available from the 'Device Info' menu:

- 1) System Information
- 2) Event Log
- 3) Diagnostics



## Operating Manual

An example of the 'Device Info' menu is shown below.

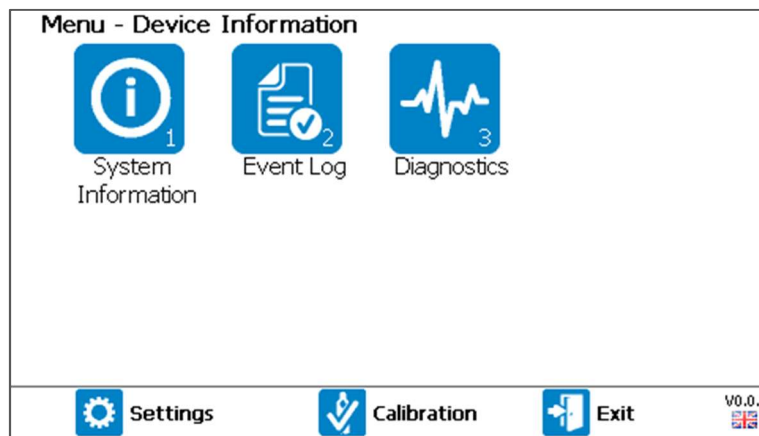

Screen 34 - Device Information menu

### System Information

This option allows the operator to view important information about their system, such as the serial number of the module, next service due date, and firmware version. This information may be required when contacting your local distributor or our technical support team for assistance.

- 1) From the 'Device Info' menu press key '1' to select the 'System Information' option.

System Information		
System Part Number:	BG3KE-0070-X1-G	
System Serial Number:	BG300001	
Manufacture Service:	01/01/70	
Last User Calibration:		
Main Board:	G300001	0.0.1
Sensor Board:	HW:1.0	FW: V1.20.157
Interface Board:	HW:0	FW: V1.2
Num of Sample points:	1	

At the bottom of the screen, there are three soft keys: 'Page Down', 'Exit', and a version number 'V0.0.1' with a small flag icon.

Screen 35 - System Information

- 2) Press the right soft key to 'Exit' back to the 'Device Info' menu.
- 3) Use the left soft key to scroll the page down and the middle soft key to scroll the page up.

### View Event Log

The BIOGAS 3000 incorporates the facility to log significant events performed on the system via the event log. This can be used as an aid to monitoring the use of the system and used as a diagnostic tool if there is a problem. Examples of events recorded would be 'alarm disabled' and 'flow has failed'.

The system stores the last 3,000 events. Older events are automatically deleted from the log.

## Operating Manual

Applicable events are stored in the event log automatically and no user intervention is required.

- 1) From the 'Device Info' menu press key '2' to select the 'View Event Log' option.

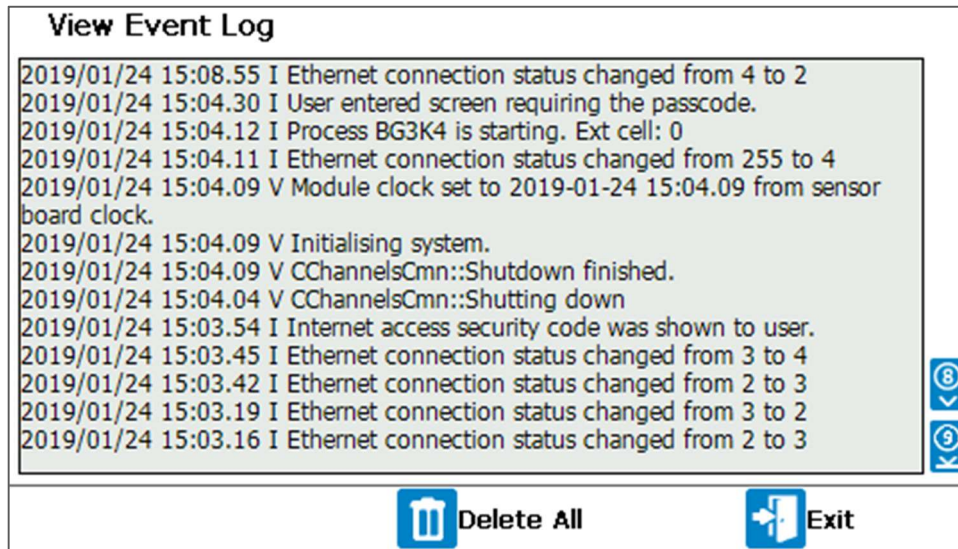

Screen 36 - View Event Log

- 2) Press the right soft key to 'Exit' back to the 'Device Info' menu.
- 3) Use keys '2' and '8' to navigate up and down through the log pages.
- 4) Use keys '3' and '9' to navigate directly to the most recent or oldest entries in the event log
- 5) Press the middle soft key to 'Delete All' logs.

### Diagnostics

This option allows the operator to view the diagnostics screen. The operator may be requested to view this screen if they contact their local distributor or our technical support team for assistance.

- 1) From the 'Device Info' menu press key '3' to select the 'Diagnostics' option.

## Operating Manual

Diagnostics					G300001
Channel	ADC	Filt	Lin	Linz	Status
CH <sub>4</sub> %	8142	8144	16.7	>>>	<input checked="" type="checkbox"/>
CO <sub>2</sub> %	7334	7331	0.6	0.6	<input checked="" type="checkbox"/>
O <sub>2</sub> %	46195	46197	14.9	14.9	<input checked="" type="checkbox"/>
Ref	10062	10067	10067	10067	<input checked="" type="checkbox"/>
Tbench °C	30024	30024	28.9	28.9	<input checked="" type="checkbox"/>

Next Page
 Previous Page
 Exit
V0.0.1

Screen 37 - Diagnostics

- 2) Press the right soft key to 'Exit' back to the 'Device Info' menu.
- 3) Use the left soft key to scroll the page down and the middle soft key to scroll the page up.

### Calibration Menu

The following options are available in the calibration menu:

- 1) Gas check
- 2) Restore to Factory
- 3) Fit New Cell
- 4) Hydrocarbon Adjustment

**Menu - Calibration**

1  
Gas Check

2  
Restore to Factory

3  
Fit New Cell

4  
Hydrocarbon Adjustment

Selecting 'Restore to factory', 'Fit New Cell' or a mixture under 'Gas Check' will stop the sampling process and freeze the outputs at their last known value!

Device Info
 Settings
 Exit

Screen 38 - Calibration menu

## Operating Manual

### Gas Check

The ability has been provided to perform a gas check and calibration on the gas channels of the system. This ensures the accuracy of the system in its current operating condition. To ensure optimum performance please ensure your BIOGAS 3000 module is returned for service and calibration on time.

**Note:** Selecting a mixture within this option will stop the sampling process and freeze the outputs at their last known value.

- 1) From the 'Calibration' menu press key '1' to select the 'Gas Check' option.

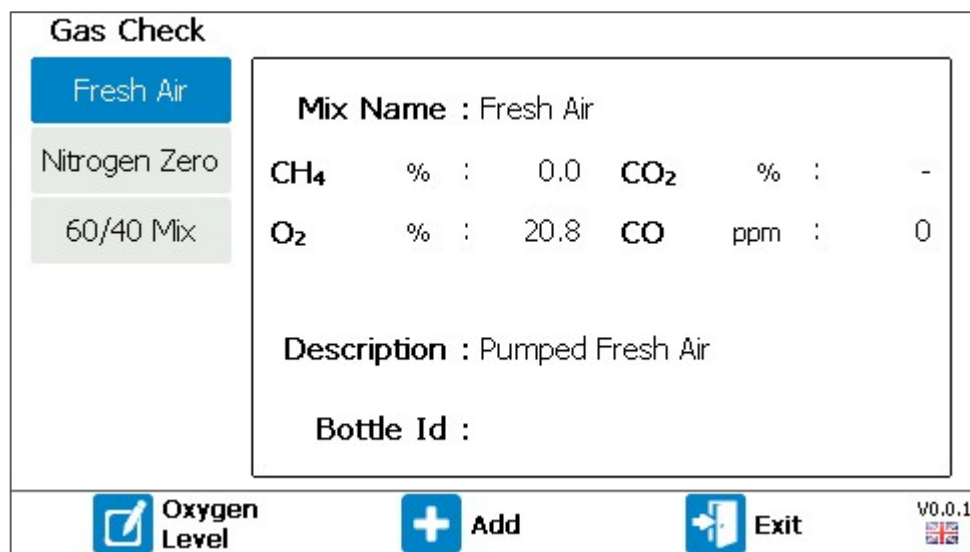

Screen 39 - Gas Check

- 2) Press the right soft key to 'Exit' back to the 'Calibration' menu.

**Note:** For more information on calibration, please refer to section [Gas Check and Calibration](#) in this operating manual.

### Restore to Factory

This option will reset the gas analyser to all of its factory programmed settings and will clear all user defined calibration points.

**Note:** Selecting this option will stop the sampling process and freeze the outputs at their last known value.

- 1) From the 'Calibration' menu press key '2' to select the 'Restore to Factory' option.

## Operating Manual

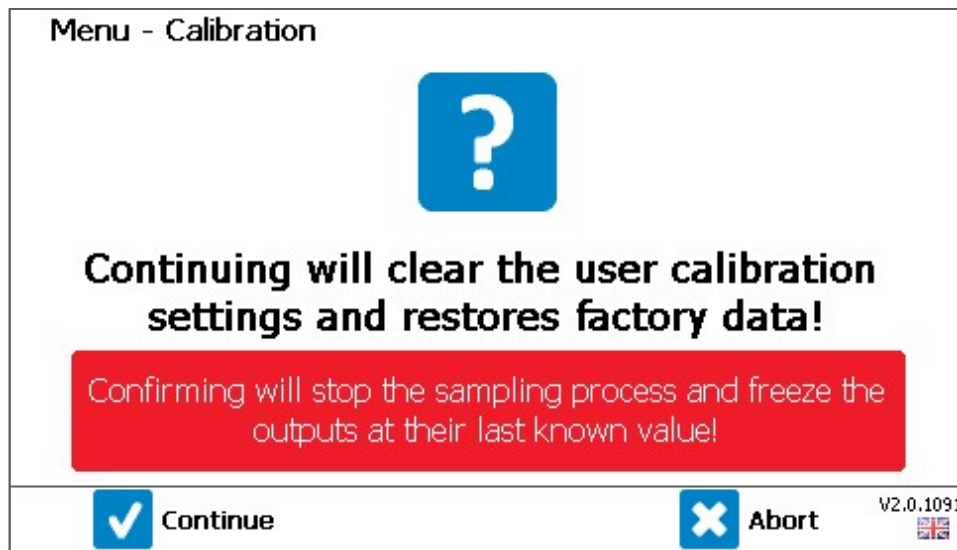

Screen 40 - Restore to Factory settings

- 2) Press the right soft key to 'Abort' which does not reset the calibration data and will return the operator to the calibration menu.
- 3) Press the left soft key to 'Continue', which resets the calibration data and will return the operator to the calibration menu.

**Note:** Restoring the system to factory settings will stop the sampling process and freeze the outputs at their last known value.

### Fit New Cell

This option should be selected when the user has installed a new pre-calibrated external cell or external sensor module (cell complete with PCB). It over-writes the current factory calibration values with the data provided with the cell.

**Note:** This option will only be available for systems where an external sensor is fitted.

**Note:** Selecting this option will stop the sampling process and freeze the outputs at their last known value.

- 1) From the 'Calibration' menu press key '3' to select the 'Fit New Cell' option.

## Operating Manual

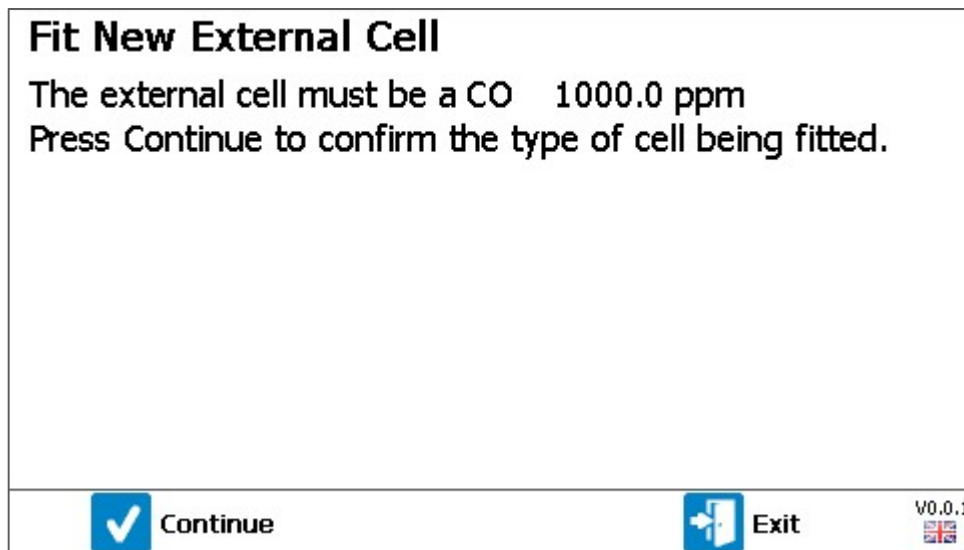

Screen 41 - Fit New External Cell confirmation

- 2) Press the right soft key to 'Exit' and return to the 'Calibration' menu.
- 3) If fitting a new cell or complete module, confirm the cell type and range, and press the left soft key to 'Continue'.

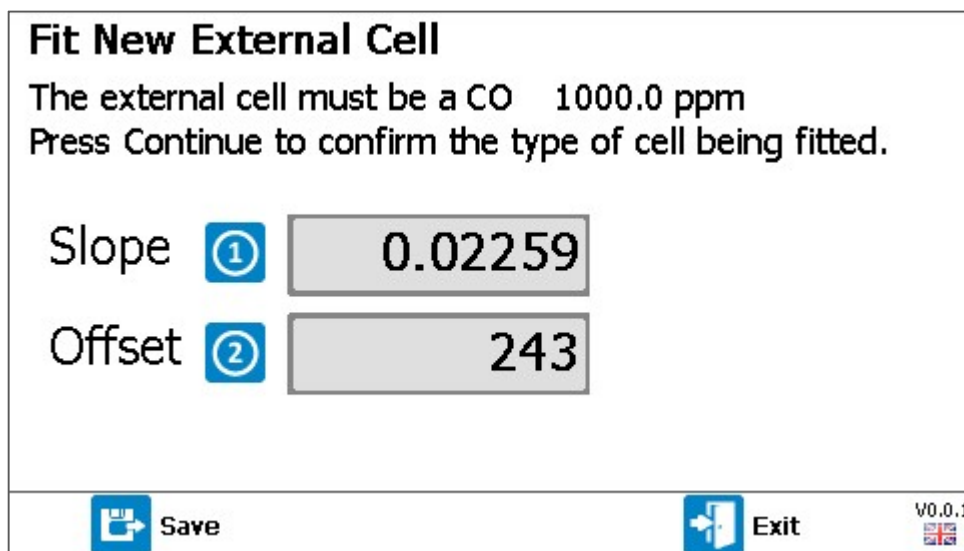

Screen 42 - Input new Slope and Offset

Note: Alongside the new cell or complete module there will be a calibration certificate containing the new slope and offset figures. Both of these values need entering in to the appropriate fields in the above screen.

- 4) Press key '1' to edit the 'Slope' or key '2' to edit the 'Offset'. Use the keypad to enter the numeric value and confirm with the  $\leftarrow$  key.
- 5) Press the left soft key to 'Save' the new configuration to memory. Following this, a prompt will appear advising the user to perform a calibration.

## Operating Manual

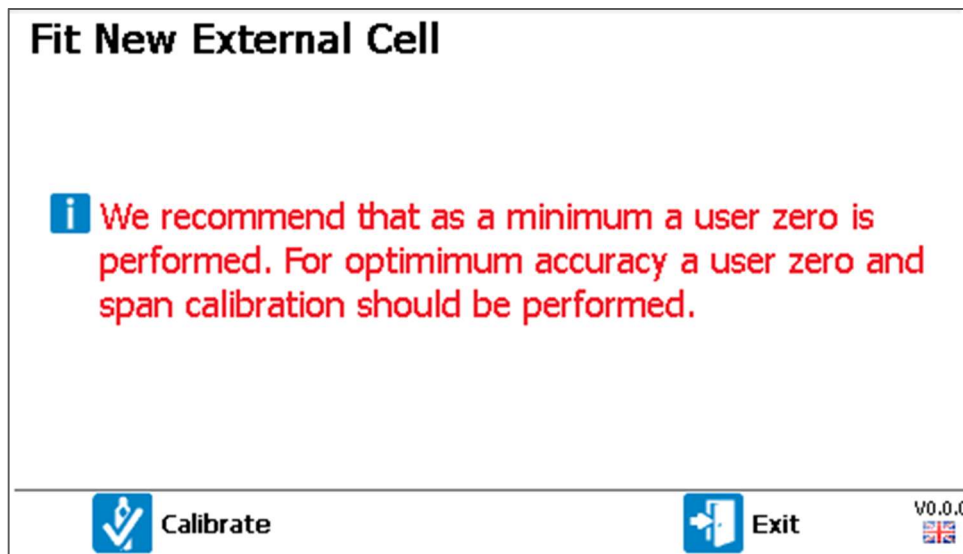

Screen 43 - User calibration recommendation

Note: After a new cell or complete module is fitted, it is recommended that as a minimum a user zero be performed. For optimum accuracy, a span calibration should be performed in addition to a zero.

- 6) Pressing the left soft key for 'Calibrate' will take the user to the ['Gas Check'](#) screen. Pressing the right soft key to 'Exit' will return the user to the 'Calibration' menu.

### Hydrocarbon Adjustment

This option will enable or disable Hydrocarbon Adjustment, which compensates the Methane (CH<sub>4</sub>) reading to account for cross-gas effects caused by other hydrocarbons present in the gas mixture.

Note: Hydrocarbon adjustment does not replace the requirement for good calibration practice. It is strongly advised that a user calibration is performed before this option is considered, refer to section [Gas Check and Calibration](#).

Press key '1' to toggle the option between 'enabled' or 'disabled'. Press left soft key 'Save and Exit' to save the setting preference.

The presence of a red triangle icon above the CH<sub>4</sub> reading displayed on the gas reading screen indicates when the CH<sub>4</sub> value has been adjusted, see also - [Gas readings](#).

The CH<sub>4</sub> reading is compensated to ensure the sum of the primary gas components measured does not exceed a total of 100% (e.g. % CH<sub>4</sub> + % CO<sub>2</sub> + % O<sub>2</sub> ≤ 100.0%).

## Operating Manual

### Hydrocarbon Adjustment

 Adjust CH4 for effects of hydrocarbons:

**Disabled**

In some cases, the Methane (CH4) reading can be affected by other gases not measured by this instrument.

Ensure that the instrument is correctly calibrated before considering this option.

Enable this option to compensate for the effect of other gases on CH4. The reading will be reduced so that the sum of CH4 + CO2 + O2 is 100.0%.

 **Exit**

Screen 44 – Hydrocarbon Adjustment



## Operating Manual

### BIOGAS 3000 Sampling Process

#### BG3K1, 2, 3, 4, and D Variants

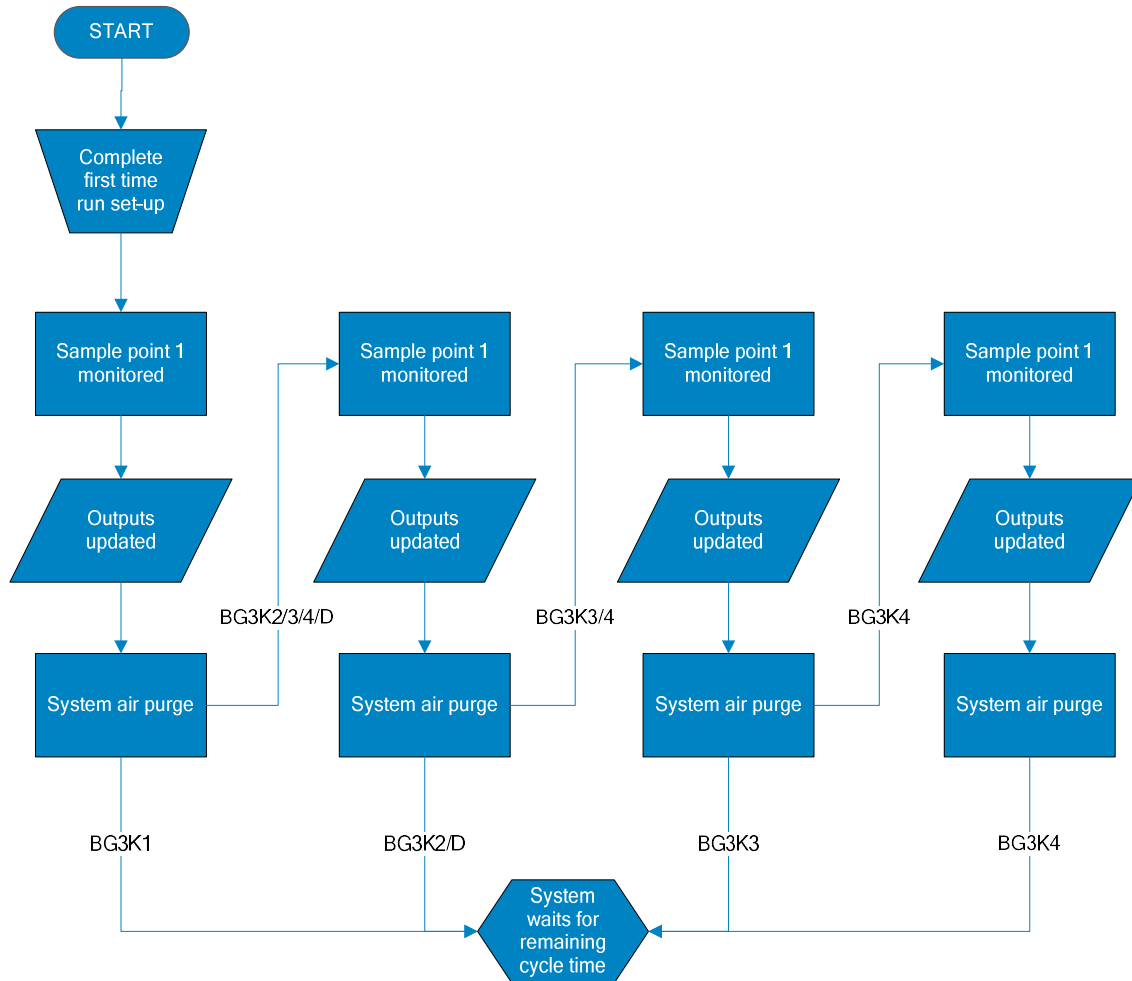

Flow Chart 1 - BG3K1, 2, 3, 4, and D

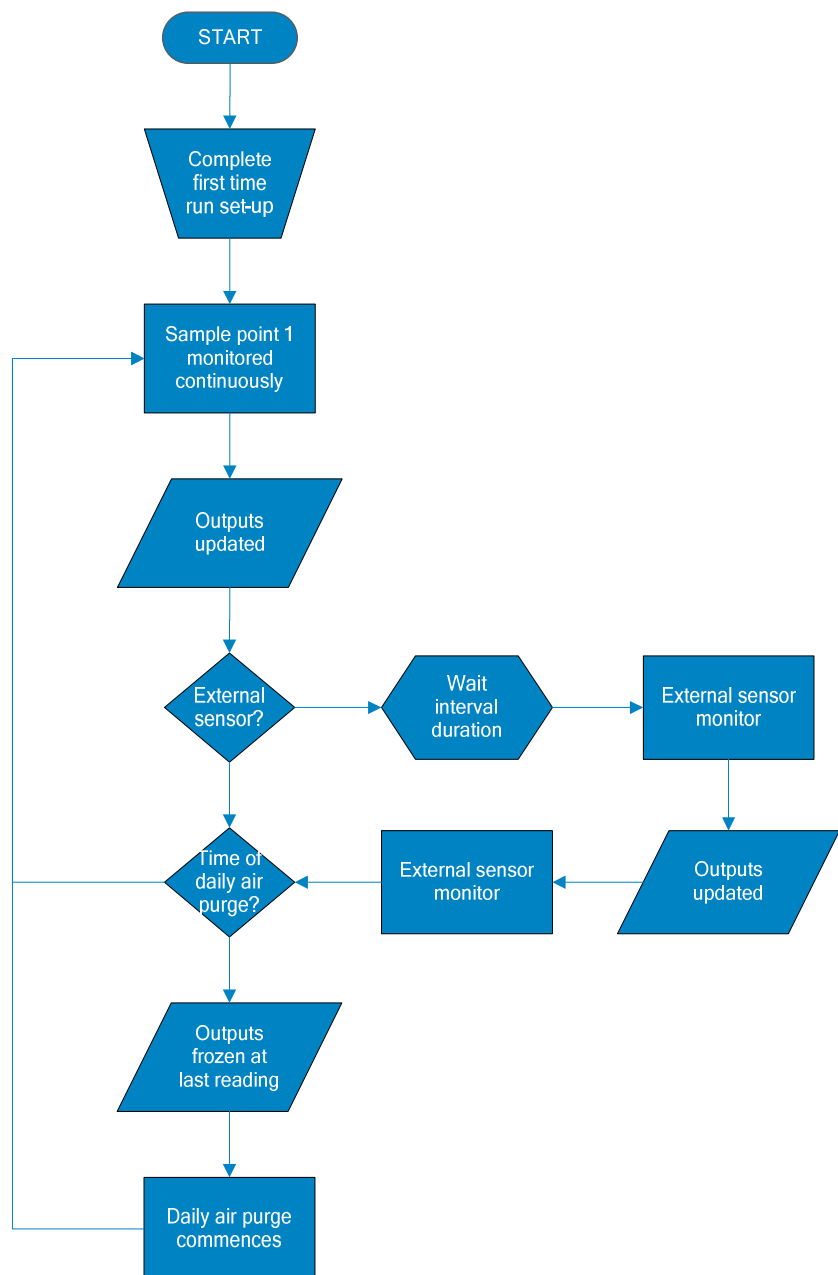

Flow Chart 2 - BG3KE

## Operating Manual

### Switching the BIOGAS 3000 System Off

The BIOGAS 3000 system can only be turned off at the switched mains supply that is installed in section [Mains Wiring](#).

The BIOGAS 3000 module can be turned off independently to the system. To do this, press and hold the on/off key for approximately two seconds. This will close all solenoids, switch off all pumps, trigger the fault relay, and freeze the outputs at their last known value. Power will remain to the system.



Screen 45 - Power off

## Operating Manual

### GAS CHECK AND CALIBRATION



Do not open when an explosive atmosphere is present.

#### Introduction

The BIOGAS 3000 system is carefully calibrated at manufacture and when returned for service using a number of gas concentrations and temperature points. However, it is sometimes desirable to carry out a gas check on the equipment to prove its accuracy and rectify any inaccuracies with a calibration process between services.

The BIOGAS 3000 measures CH<sub>4</sub>, CO<sub>2</sub>, and O<sub>2</sub> as standard with optional additional gases and these channels can be user calibrated. This section will describe in detail the correct procedure to gas check and calibrate these gas channels.

**Note:** This does not replace the factory service and calibration.

**Note:** If this calibration is completed incorrectly, it may decrease the accuracy of the system.

Four important terms that are used within this section are:

**Gas check:** This is where a known concentration of gas is applied to the system and its responses are checked with no adjustment being made.

**Calibration:** This is when an adjustment is made to the modules readings after a gas check has been performed, by either a zero, span, or both.

**Zero:** The point at which the system is calibrated when there is none of the target gas present.

**Span:** The point at which the system is calibrated when there is a known concentration of the target gas present.

**Note:** A more detailed explanation of user calibration can be found in section [User Calibration Explained](#).

#### Required Equipment

##### Gas

User calibration of the system will greatly improve the data accuracy in the range of the calibration gas used and the environmental conditions for which the BIOGAS 3000 is calibrated. This may cause less accurate readings of concentrations outside of this calibrated range.

Users should select the correct calibration gas for the expected gas levels on their particular application. In addition, nitrogen (N<sub>2</sub>) can be used for a zero calibration. If this is not available, then clean ambient air can be used.

## Operating Manual



Calibration gases can be dangerous. For each gas used, the appropriate material safety data sheet must be read and fully understood before proceeding.

### Flow Regulator

It is recommended that the regulator available via QED be used as it has been configured to deliver a fixed flow of 300ml/min and correct pressure relief to avoid damage to the system (see QED part number GA6.8 in [BIOGAS 3000 Consumable Products](#)). As the regulator's flow is factory set it only requires a few turns to open, no adjustment will be necessary.

**Note:** If using a regulator that was not supplied by QED, please ensure the flow rate is adjusted to a maximum of 300ml/min. Suitable pressure relief should be ensured to protect the system from damage because of over-pressurisation – typically 3-5psi (200-350mbar).

When the system is being calibrated, in cases of over-pressurisation, the 1/16" port on the red pressure relief valve (supplied with the QED pressure regulator) will release gas to protect the BIOGAS 3000 module.



It is recommended that the exhaust tubing from the pressure relief valve emerge in a well-ventilated area.

Ensure there are no leaks in the tubing and connections before carrying out a user calibration.

The calibration of the BIOGAS 3000 should be carried out by trained personnel taking all necessary precautions when using dangerous, explosive, or toxic gases.

### Gas Mixtures

The BIOGAS 3000 provides the user with the ability to add, edit, or delete gas mixtures that can be used for the gas check and calibration process. There are three default mixtures:

- Fresh Air – assumed values of fresh air are CH<sub>4</sub> 0.0%, O<sub>2</sub> 20.8, and all other optional gasses 0ppm. CO<sub>2</sub> is not available to calibrate in air.

**Note:** The oxygen concentration is editable between 20.8% and 21.0% - see [Edit O2 in Fresh Air Mix](#).

- Nitrogen Zero – known values of CH<sub>4</sub> 0.0%, O<sub>2</sub> 0.0%, and all other optional gasses 0ppm. CO<sub>2</sub> is not available to calibrate in nitrogen.

**Note:** A new mixture can be created which will allow the CO<sub>2</sub> channel to be zeroed if required. If zeroing the CO<sub>2</sub> channel, the countdown timer will increase from three minutes to five.

- 60/40 Mix – default values of CH<sub>4</sub> 60.0%, O<sub>2</sub> 40.0%, with O<sub>2</sub> 0.0% and all other optional gasses

## Operating Manual

Oppm.

Note: The CH<sub>4</sub> and CO<sub>2</sub> values should be edited with the true bottle concentration.

**Gas Check**

Fresh Air

Nitrogen Zero

60/40 Mix

**Mix Name :** Fresh Air

<b>CH<sub>4</sub></b>	% :	0.0	<b>CO<sub>2</sub></b>	% :	-
<b>O<sub>2</sub></b>	% :	20.8	<b>CO</b>	ppm :	0

**Description :** Pumped Fresh Air

**Bottle Id :**

Oxygen Level    + Add    Exit    V0.0.1

Screen 46 - Gas Check

### Adding a Mixture

In addition to the three default mixtures, the BIOGAS 3000 also supports the addition of three user definable mixtures. To add a mix:

- 1) In the 'Gas Check' screen, press the middle soft key to 'Add' a mix.

**Gas Check**

Fresh Air

Nitrogen Zero

60/40 Mix

**Mixture :** AIR

A-Z 0-9    Delete    Cancel    V0.0.0

Screen 47 - Add gas mixture

- 2) Using the keypad, enter a name for the mixture. Pressing the left soft key toggles between letter and number entry. Press ↵ when complete.

## Operating Manual

**Edit Gas Mix**

Name:

Description:

Bottle Id:

<b>CH<sub>4</sub></b>	(%) :	<input type="text" value="-"/>	<b>CO<sub>2</sub></b>	(%) :	<input type="text" value="-"/>
<b>O<sub>2</sub></b>	(%) :	<input type="text" value="-"/>	<b>H<sub>2</sub></b>	(ppm) :	<input type="text" value="-"/>



**Save and  
Exit**



**Exit**

V0.0.0



Screen 48 - Edit gas mix details

- 3) Using the scroll keys, select an editable field and press  $\leftarrow$  the key to edit:
  - Name, Description and Bottle ID are text and number fields
  - Gas channels are number fields. Enter the gas concentration of the bottle in percent or ppm. A ' - ' will not perform an action on the channel. Entering a gas concentration will span the channel, entering a '0' will zero the channel.
- 4) Press the middle soft key to 'Save and Exit'.

**Note:** The gas concentrations for the 60/40 Mix and the three customer definable mixtures are editable using the left soft key when highlighting the mix in the 'Gas Check' screen.

### Deleting a Mix

**Note:** The three default mixtures cannot be deleted.

To delete a gas mix in the 'Gas Check' screen:

- 1) Use the scroll keys to highlight the mix to be deleted.

## Operating Manual

- 2) Press the middle soft key to 'Add/Delete'.



Screen 49 - Add or delete mix

- 3) Press the middle soft key to 'Delete'.
- 4) Press the left soft key (Yes) to confirm deletion.

### Edit O2 in Fresh Air Mix

The concentration of oxygen in the fresh air mix is editable between 20.8 and 21.0%. To change the concentration used:

- 1) Highlight the 'Fresh Air' mix.
- 2) Press the left soft key to edit the 'Oxygen Level'.

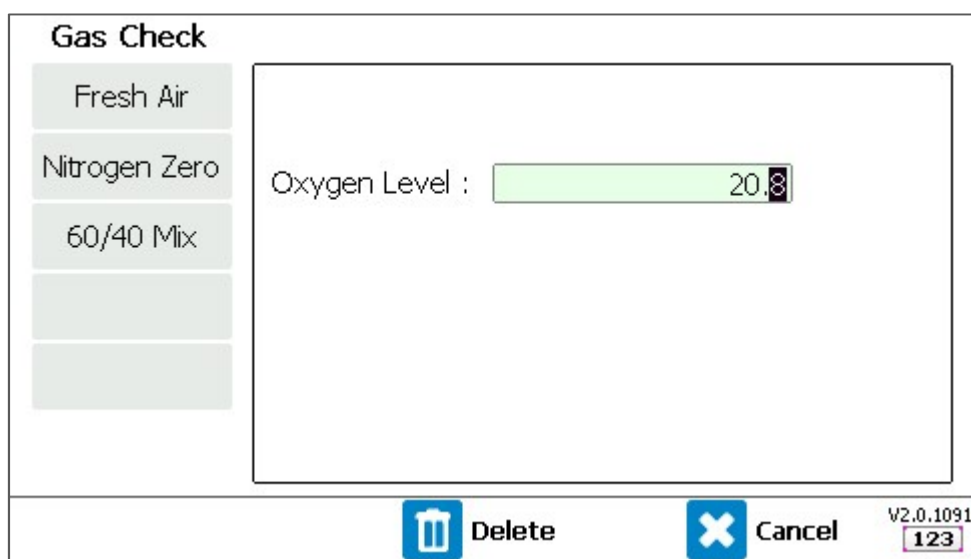

Screen 50 - Edit oxygen concentration



## Operating Manual

- 3) Pressing the right soft key will 'Cancel' the edit.
- 4) Key in the concentration you wish to span the oxygen channel to in fresh air, followed by the  key to confirm. The operator will be returned to the 'Gas Check' screen.

### Connecting a Gas Bottle to the BIOGAS 3000

This section explains how to connect a gas bottle to the BIOGAS 3000 system in preparation for a gas check or calibration.



Do not open when an explosive atmosphere is present.

Mains voltages are present within the BIOGAS 3000 system and great care needs to be observed. If there is any uncertainty, seek advice from a professional.





Pressurised gas bottles can be dangerous and great care needs to be taken when in use.

Alternatively, contact your local distributor, or our technical support team at QED on +44(0)333 800 0088 or email [technical@qedenv.co.uk](mailto:technical@qedenv.co.uk) to arrange a site visit. (Please note a charge may be applicable.)

Op.	Image	Instruction
1		<p>Ensure the drain valve is closed.</p> <div style="border: 1px solid black; padding: 5px; margin-top: 10px;"> <p><b>Note: The three default mixtures cannot be deleted.</b></p> </div>
2		<p>Ensure the gas inlet and gas outlet valves are closed.</p>

## Operating Manual

3		<p>Disconnect the QRC from the top of the catchpot.</p>
4		<div style="border: 1px solid purple; padding: 5px; margin-bottom: 10px;"> <p><b>Note: Ensure the pressure regulator is turned off.</b></p> </div> <p>Attach the pressure regulator to the gas bottle and ensure it is adequately tightened.</p>

Ensure that the regulator is fitted to the bottle at arm's length in case of a gas leak.

 Ensure that no cross threading occurs during tightening of the regulator.

During the rare occasion that gas does leak from the seal, place the bottle and regulator on the floor and leave the area until the leak has stopped. **DO NOT** attempt to solve the leak as this could be dangerous.

5		<p>Ensure that the gas bottle has adequate pressure (i.e. is not empty).</p>
---	---	--

## Operating Manual

6		<p>Attach the tubing from the gas bottle and regulator to the QRC.</p>
---	---	--

### Gas Check and Calibration

After the BIOGAS 3000 system has been installed and pressure tested, it is recommended that a gas check be performed to ensure it is still accurate, as damage could have occurred during installation and/or transit.

In addition, a gas check can be performed as part of regular maintenance to validate the accuracy of the system and determine whether a user calibration is required.

The gas used for a check or calibration should be representative of the gas within the application, for example, 60% CH<sub>4</sub> balanced with 40% CO<sub>2</sub>.

The BIOGAS 3000 performs a gas check before providing the user with a decision. If the result of the check is that the instruments accuracy is good, a calibration may not need to be performed. At this point, the user can decide to record the results and exit. Alternatively, the accuracy may need improving and at this point, the user can decide to correct the errors by way of a user calibration. This will adjust the figures and record the calibration to memory.

[Flow Chart 3 - Gas Check and Calibration](#) is a simple overview of the process:

**Note:** It is QED's recommendation that a zero check and calibration is carried out before a span check and calibration.

**Note:** When selecting a mixture in the 'Gas Check' screen, the sampling process will be stopped.

## Operating Manual

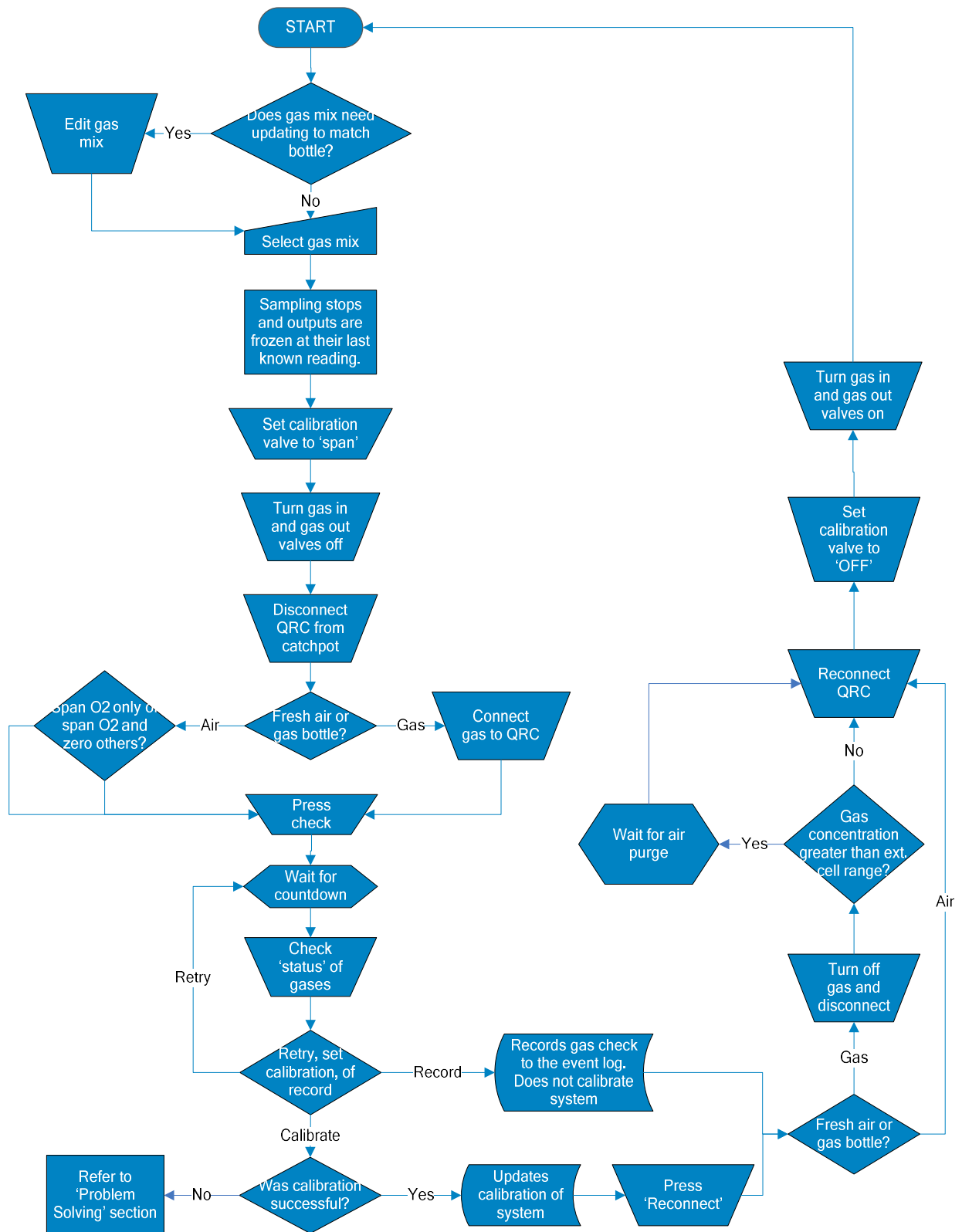





Flow Chart 3 - Gas Check and Calibration

## Operating Manual



### Status Icons

Below is a list of status icons used after the gas check and calibration processes and their definition:

#### Post Gas Check

Icon	Definition
	Channel has not been checked
	Recommends a calibration be performed
	Channel is outside of limits – see <a href="#">User Calibration Explained</a>
	Channel is within limits and may not need adjusting

#### Post Calibration

Icon	Definition
	Channel has not been checked
	Channel was not calibrated due to an error – see <a href="#">User Calibration Explained</a>
	Channel was calibrated OK

## Operating Manual

### Disconnecting a Gas Bottle from the BIOGAS 3000

This section explains how to disconnect a gas bottle from the BIOGAS 3000 system following a gas check or calibration.

Do not open when an explosive atmosphere is present.

Mains voltages are present within the BIOGAS 3000 system and great care needs to be observed. If there is any uncertainty, seek advice from a professional.





Pressurised gas bottles can be dangerous and great care needs to be taken when in use.

Alternatively, contact your local distributor, or our technical support team at QED on +44(0)333 800 0088 or email [technical@qedenv.co.uk](mailto:technical@qedenv.co.uk) to arrange a site visit. (Please note a charge may be applicable.)

Op.	Image	Instruction
1	No image	Ensure the pressure regulator is turned off.
2		Ensure the drain, gas inlet and gas outlet valves are still closed.
3		Ensure the gas bottle supply is turned off and disconnect the tubing of the gas bottle and regulator from the QRC.

## Operating Manual

4		<p>Reconnect the system tubing by connecting the QRC to the top of the catchpot.</p> <div style="border: 1px solid black; padding: 5px; margin-top: 10px;"> <p><b>Note:</b> Ensure that the coupling 'clicks' in to place.</p> </div>
5	<p>No image</p>	<p>Remove the regulator from the gas bottle and store both appropriately to avoid damage.</p>
6		<p>Open the gas inlet and gas outlet valves.</p> <div style="border: 1px solid black; padding: 5px; margin-top: 10px;"> <p><b>Note:</b> The drain valve is to remain closed.</p> </div>



It is critical that the connections are fully secured to ensure that no gas leaks in to the main enclosure.

Once the BIOGAS 3000 tubing has been reconnected, it is recommended that a [Pressure Test](#) be completed to ensure that the system is leak free.

## Operating Manual

### MAINTENANCE

This section outlines the maintenance requirements which the operator needs to perform on the system and instructions for user replaceable components.

**Note:** For further information please contact your local distributor, or our technical support team at QED on +44(0)333 800 0088 or email [technical@qedenv.co.uk](mailto:technical@qedenv.co.uk).

Do not open when an explosive atmosphere is present.



The use of non-QED approved parts being fitted to the equipment may cause a hazard and will invalidate the hazardous area certification.

The system should not be altered in any way other than described in this operating manual. Alterations outside of this operating manual could cause a hazard, make the equipment unsafe voiding the warranty and ATEX/IECEx certification.

### Maintenance Schedule

**Note:** This maintenance schedule is a minimum guide and dependent upon the application and usage of the BIOGAS 3000 system, may need to be adapted accordingly.

As a minimum, QED recommend that each month the following be undertaken to ensure the BIOGAS 3000 system is in its optimum working and safe condition:

- Inspect the BIOGAS 3000 system for damage
- Review the installation location for continued suitability (i.e. physical and environmental conditions)
- Check the main enclosure gasket for damage to ensure the IP rating can be maintained
- Inspect the interior of the enclosure for damage or condensation (particularly in locations of high external humidity)
- Ensure screws have remained tightened to the recommended torque settings below and there are no visible signs of corrosion

Type	Torque (N·m)
M3	0.5
M4	1.1
M6	4.0
M8	10
DIN Rail Terminals/Connectors	0.6
Terminal Block Connectors	0.2



## Operating Manual



All terminals including unused terminals shall be tightened as per the operating manual. Failure to meet the above requirements could make the equipment unsafe resulting in a hazard and invalidate the hazardous area certification.

- Empty the catchpot (see [Emptying the Catchpot](#))
- Inspect, and replace if required, the coalescing catchpot filter (see [Replacing the Catchpot Filter](#))
- Inspect, and replace if required, the inline PTFE filter (see [Replacing the Inline PTFE Filter](#))
- Perform a pressure test to ensure there are no leaks (see [Pressure Test](#))
- Perform a gas check to determine the accuracy of the system and if required a calibration (see [Gas Check and Calibration](#)).

Note: It is the operator's responsibility to keep a record of when and what maintenance has been performed.

Note: If you suspect the BIOGAS 3000 system to have been damaged and are unsure of the consequences of this, please contact your local distributor, or our technical support team at QED on +44(0)333 800 0088 or email [technical@qedenv.co.uk](mailto:technical@qedenv.co.uk).

Note: Inspection of the catchpot and inline filter may be required more frequently depending upon the application and the likelihood of liquid in the sample gas.

Note: After performing a gas check or calibration, it may be necessary to perform a further pressure test on the equipment to ensure it has remained leak free.



Dependent upon the application, the equipment can come in to contact with unsafe contaminants. It is therefore recommended that suitable PPE is identified and worn (such as gloves) and hands are washed thoroughly after maintenance is completed.

## Operating Manual

### BIOGAS 3000 Consumable Products

Optional replacement parts may be purchased for the BIOGAS 3000 from your local distributor or QED directly. Refer to the next page for part numbers:



## Operating Manual

Ref	Description	Part Number
A	Catchpot with coalescing filter and built-in valve for systems without auto-drain	BG3K.S1
B	Catchpot with coalescing filter and drainage tubing for systems with auto-drain	BG3K.S2
C	BIOGAS 3000 Profibus option	BG3K.S3
D	BIOGAS 3000 Profinet option	BG3K.S4
E	Filter, Exhaust 1/4 MNPT (used as air purge filter)	2008277/S
F	Inline PTFE filters (pack of 10) Inline PTFE filters (pack of 30)	GA4.2 GA4.2(30)
G	Pre-calibrated external sensor module	Please contact us
H	Check gas regulator used in conjunction with calibration gas canister. This valve controls the flow of gas – c/w safety valve.	GA6.8
I	Pre-calibrated external sensor	Please contact us
J	5m length 4mm I.D tubing	GA3K.S6
K	Calibration gas	Please contact us
L	Coalescing filter for catchpot x 5	GA3K.S1
M	Fuses	Please contact us
N	External catchpot option	GA3KP.S15
O	BIOGAS 3000 Ethernet option	BG3K.S40
P	BIOGAS 3000 Pressure Test Kit	BG3K.S48

## Operating Manual

### Emptying the Catchpot

Do not open when an explosive atmosphere is present.



Mains voltages are present within the BIOGAS 3000 system and great care needs to be observed. If there is any uncertainty, seek advice from a professional or isolate the supply. Alternatively, contact your local distributor, or our technical support team at QED on +44(0)333 800 0088 or email [technical@gedenv.co.uk](mailto:technical@gedenv.co.uk) to arrange a site visit. (Please note a charge may be applicable.)

**Note:** This process is only applicable for systems without auto-drain.

Op.	Image	Instruction
1		<p>From the 'Gas Readings Screen', press the middle soft key to 'Stop Sampling'.</p> <p><b>Note:</b> If required, press the middle soft key once more to fix the outputs at their safe values.</p>
2		<p>Ensure the drain, gas inlet, and gas outlet valves are closed.</p>
3		<p>Disconnect the QRC from the top of the catchpot.</p>

## Operating Manual

4		<p>Open the drain valve to allow liquid to empty from the catchpot.</p>
---	---	---



The catchpot can hold approximately 90ml of liquid. Dependent upon the application the liquid removed may be contaminated and should be discharged to an area where it is safe to do so.

This line may also vent sample gas for a brief period during each draining operation if the sample inlet and gas out valves are not closed.

5		<p>Once the catchpot has emptied, close the drain valve.</p>
---	--	--

6		<p>Reconnect the system tubing by connecting the QRC to the top of the catchpot.</p> <div data-bbox="858 1496 1385 1599" style="border: 1px solid purple; padding: 5px;"> <p><b>Note:</b> Ensure that the coupling 'clicks' in to place.</p> </div>
---	---	---



It is critical that the connections are fully secured to ensure that no gas leaks in to the main enclosure.

## Operating Manual

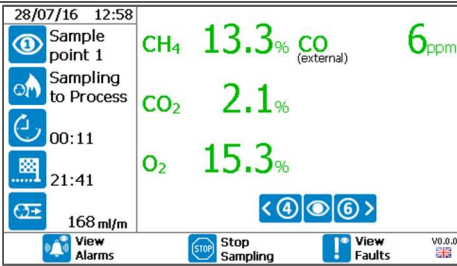
7		Open the gas inlet and gas outlet valves.
8		From the sampling stopped screen, press the left soft key to 'Restart' the monitoring process and return to the 'Gas Readings Screen'.

 Once all maintenance is completed, it is recommended that a [Pressure Test](#) be completed to ensure that the system is leak free.

## Operating Manual

### Replacing the Catchpot Filter

Do not open when an explosive atmosphere is present.







Mains voltages are present within the BIOGAS 3000 system and great care needs to be observed. If there is any uncertainty, seek advice from a professional or isolate the supply. Alternatively, contact your local distributor, or our technical support team at QED on +44(0)333 800 0088 or email [technical@gedenv.co.uk](mailto:technical@gedenv.co.uk) to arrange a site visit. (Please note a charge may be applicable.)

The coalescing catchpot filter should be replaced if showing signs of contamination. Failure to replace the filter will result in the gas flow being restricted or blocked to the BIOGAS 3000 module. In addition, it will cause a flow fail error.



Op.	Image	Instruction																																			
1	No image	Drain the catchpot of any contents. Refer to <a href="#">Emptying the Catchpot</a> .																																			
2	<table border="1"> <thead> <tr> <th>Output</th> <th>SP</th> <th>Gas</th> <th>Reading</th> <th>mA</th> </tr> </thead> <tbody> <tr> <td>1</td> <td>1</td> <td>CO2</td> <td>0.0</td> <td>4.0</td> </tr> <tr> <td>2</td> <td>All</td> <td>O2</td> <td>5.5</td> <td>7.5</td> </tr> <tr> <td>3</td> <td></td> <td>(Disabled)</td> <td></td> <td></td> </tr> <tr> <td>4</td> <td></td> <td>(Disabled)</td> <td></td> <td></td> </tr> <tr> <td>5</td> <td></td> <td>(Disabled)</td> <td></td> <td></td> </tr> <tr> <td>6</td> <td></td> <td>(Disabled)</td> <td></td> <td></td> </tr> </tbody> </table>	Output	SP	Gas	Reading	mA	1	1	CO2	0.0	4.0	2	All	O2	5.5	7.5	3		(Disabled)			4		(Disabled)			5		(Disabled)			6		(Disabled)			<p>From the 'Gas Readings Screen', press the middle soft key to 'Stop Sampling'.</p> <p><b>Note:</b> If required, press the middle soft key once more to fix the outputs at their safe values.</p>
Output	SP	Gas	Reading	mA																																	
1	1	CO2	0.0	4.0																																	
2	All	O2	5.5	7.5																																	
3		(Disabled)																																			
4		(Disabled)																																			
5		(Disabled)																																			
6		(Disabled)																																			
3		Ensure the drain, gas inlet, and gas outlet valves are closed.																																			
4		Disconnect the gas in and gas out tubes from the catchpot assembly.																																			

## Operating Manual

5		<p>Remove the catchpot from its clip.</p>
6		<ol style="list-style-type: none"> <li>1) Unscrew the catchpot top by turning a quarter turn anti-clockwise.</li> <li>2) Lift the top from the body.</li> </ol>
7		<p>Unscrew the filter stop from underneath the filter.</p> <div style="border: 1px solid black; padding: 5px; margin-top: 10px;"> <p><b>Note: Keep the filter stop safe.</b></p> </div>
8		<p>Remove the coalescing filter from the threaded bar and replace with new.</p>

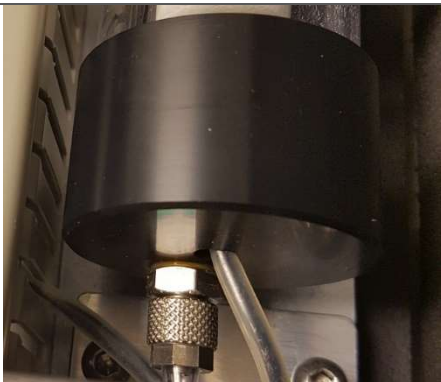

## Operating Manual

9		<p>Replace the filter stop and tighten into place.</p>
10		<ol style="list-style-type: none"> <li>1) Align and fit the catchpot top to the body.</li> <li>2) Tighten the catchpot top by turning a quarter turn clockwise.</li> </ol>
11		<p>Fit the catchpot back in to its clip.</p>
12		<p>Gently position the catchpot so that the drain tube is closest to the backplate and the female QRC is facing the front.</p>

## Operating Manual

13		<p>Once secure, reconnect the couplings to the catchpot top, ensuring the tubing is not trapped or kinked.</p> <div style="border: 1px solid black; padding: 5px; margin-top: 10px;"> <p><b>Note:</b> Ensure that the couplings ‘clicks’ in to place.</p> </div>
----	---	--

 It is critical that the connections are fully secured to ensure that no gas leaks in to the main enclosure.

14		<p>Open the gas inlet and gas outlet valves.</p>
----	--	--

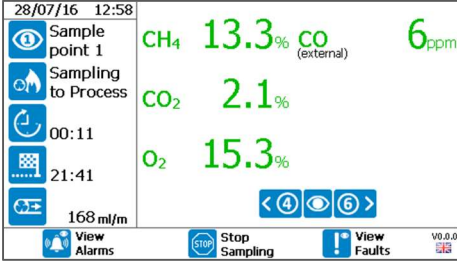
15		<p>From the sampling stopped screen, press the left soft key to ‘Restart’ the monitoring process and return to the ‘Gas Readings Screen’.</p>
----	---	---

 Once all maintenance is completed, it is recommended that a [Pressure Test](#) be completed to ensure that the system is leak free.

## Operating Manual

### Replacing the Inline PTFE Filter

Do not open when an explosive atmosphere is present.







Mains voltages are present within the BIOGAS 3000 system and great care needs to be observed. If there is any uncertainty, seek advice from a professional or isolate the supply. Alternatively, contact your local distributor, or our technical support team at QED on +44(0)333 800 0088 or email [technical@gedenv.co.uk](mailto:technical@gedenv.co.uk) to arrange a site visit. (Please note a charge may be applicable.)

The inline PTFE filter should be replaced if showing signs of contamination or saturated with liquid. Failure to replace the filter will result in the gas flow being restricted or blocked to the BIOGAS 3000 module. In addition, it will cause a flow fail error.

Op.	Image	Instruction																																			
1	<table border="1"> <thead> <tr> <th>Output</th> <th>SP</th> <th>Gas</th> <th>Reading</th> <th>mA</th> </tr> </thead> <tbody> <tr> <td>1</td> <td>1</td> <td>CO2</td> <td>0.0</td> <td>4.0</td> </tr> <tr> <td>2</td> <td>All</td> <td>O2</td> <td>5.5</td> <td>7.5</td> </tr> <tr> <td>3</td> <td></td> <td>(Disabled)</td> <td></td> <td></td> </tr> <tr> <td>4</td> <td></td> <td>(Disabled)</td> <td></td> <td></td> </tr> <tr> <td>5</td> <td></td> <td>(Disabled)</td> <td></td> <td></td> </tr> <tr> <td>6</td> <td></td> <td>(Disabled)</td> <td></td> <td></td> </tr> </tbody> </table>	Output	SP	Gas	Reading	mA	1	1	CO2	0.0	4.0	2	All	O2	5.5	7.5	3		(Disabled)			4		(Disabled)			5		(Disabled)			6		(Disabled)			<p>From the 'Gas Readings Screen', press the middle soft key to 'Stop Sampling'.</p> <div style="border: 1px solid black; padding: 5px; margin-top: 10px;"> <p><b>Note: If required, press the middle soft key once more to fix the outputs at their safe values.</b></p> </div>
Output	SP	Gas	Reading	mA																																	
1	1	CO2	0.0	4.0																																	
2	All	O2	5.5	7.5																																	
3		(Disabled)																																			
4		(Disabled)																																			
5		(Disabled)																																			
6		(Disabled)																																			
2		<p>Ensure the drain, gas inlet, and gas outlet valves are closed.</p>																																			
3		<p>The inline PTFE filter is located above the catchpot.</p>																																			

## Operating Manual

4		<p>Disconnect one side of the tubing from the filter by turning anti-clockwise.</p>
5		<p>Disconnect the remaining tubing length from the filter by turning anti-clockwise.</p>
6		<p>Connect the new filter to the tubing by turning clockwise.</p>
7		<p>Connect the remaining tube to the filter by turning clockwise.</p>

## Operating Manual

8		Position the tubing assembly above the catchpot ensuring the tubing is not trapped or kinked.
---	---	---

 It is critical that the connections are fully secured to ensure that no gas leaks in to the main enclosure.

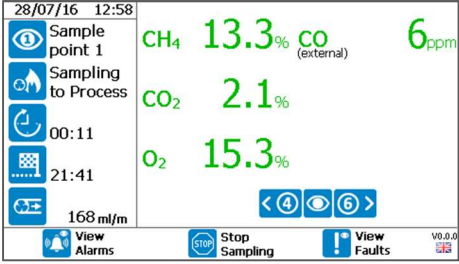
9		Open the gas inlet and gas outlet valves.
10		From the sampling stopped screen, press the left soft key to 'Restart' the monitoring process and return to the 'Gas Readings Screen'.

 Once all maintenance is completed, it is recommended that a [Pressure Test](#) be completed to ensure that the system is leak free.

## Operating Manual

### Pressure Test



Gas leaking into the enclosure could create a potentially explosive atmosphere. It is the user's responsibility to ensure that routine pressure tests are performed after installation and as part of regular maintenance.

Failure to perform routine pressure tests or a pressure test after maintenance could result in gas leaking inside the enclosure causing a hazard or damaging the equipment.

After any maintenance operations in this section are performed, the system must be pressure tested to ensure it is leak free.

In addition, a pressure test should be performed as part of routine maintenance. The following sections outline the required equipment, the set-up, and the procedure for the pressure test on the different systems available.



Do not open enclosure when an explosive atmosphere is present.

### Required Equipment

To perform the test procedure, the following equipment will be required:

- QED Pressure Test Kit (part number BG3K.S48)
- OR
- 0-200mbar pressure gauge with minimum of 10mbar increments
  - T-piece fitting suitable for tubing
  - A ball valve
  - Pressure application device, such as a manual pump
  - Fittings and tubing to connect to the system bulkheads (6mm OD compression, ¼" BSPT)

**Note:** An additional two ball valves will be required if not installed on the 'process return' and 'vent to atmosphere' outlets as recommended during the installation.



Do not use liquid leak detector in the BIOGAS 3000 system, as there are mains voltages present. This could result in an electric shock leading to injury and in some cases may be fatal.

## Operating Manual



### Diagnostics Control Mode

The BIOGAS 3000 includes a feature that allows the user to toggle the condition of the solenoids, relays, and pumps in the system. During the pressure systems tests, the user will need to control the position of the solenoid valves in order to complete a comprehensive test. To enable diagnostics control mode:

- 1) From the 'Gas Readings Screen' press the 'Menu' key.
- 2) Press the left soft key for the 'Device Info' menu.
- 3) Press key '3' for 'Diagnostics'.
- 4) Press the 'pump' key to display 'Diagnostics Control Mode'.

Note: Entering this mode of operation will stop the sampling process.

Diagnostics				G300001	
Id	Pump	Relay	Solenoid	4-20mA Out	4-20mA In
1	<input type="checkbox"/> OFF	<input type="checkbox"/> OFF	<input type="checkbox"/> OFF	0.00	4.50
2	<input checked="" type="checkbox"/> ON	<input checked="" type="checkbox"/> ON	<input type="checkbox"/> OFF	0.00	
3	<input type="checkbox"/> OFF	<input checked="" type="checkbox"/> ON	<input type="checkbox"/> OFF	0.00	
4		<input type="checkbox"/> OFF	<input type="checkbox"/> OFF	0.00	
5		<input type="checkbox"/> OFF	<input type="checkbox"/> OFF	0.00	
6		<input checked="" type="checkbox"/> ON	<input checked="" type="checkbox"/> ON	0.00	
7		<input type="checkbox"/> OFF			
8		<input type="checkbox"/> OFF			

 **Exit**
V0.0.0  

Screen 51 – Diagnostics Control Mode

- 5) Using the scroll keys, navigate to the desired parameter. Pressing the  $\leftarrow$  key will toggle the status of the hardware item between on and off.
- 6) Pressing the right soft key at any point will return the user to the 'Device Info' menu.

Note: After returning to the 'Gas Readings Screen' after being in diagnostics control mode, the sampling process will start from the beginning.

## Operating Manual

### General Set-Up

The image below shows an example of how the equipment will look when performing the test procedure.

Note: Due to the significant differences between models, each set-up will be slightly different to the image shown.

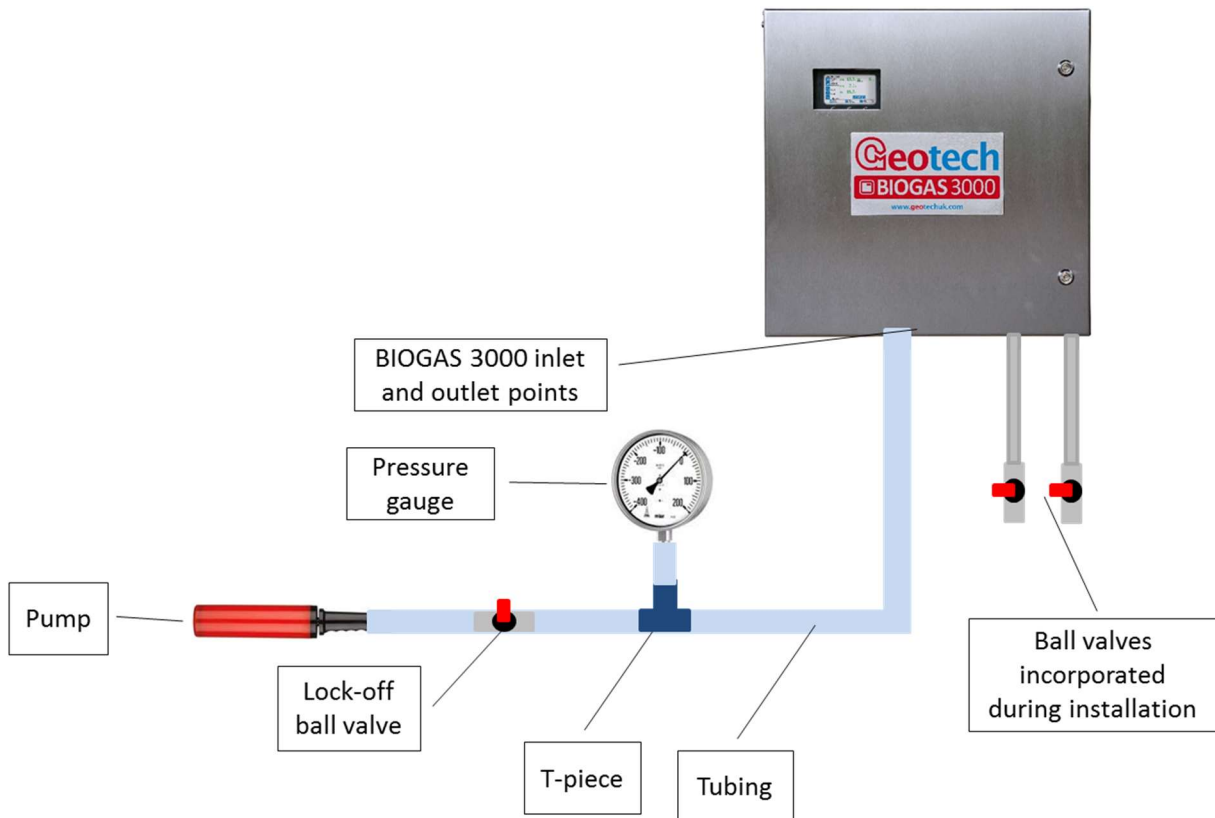

### Performing the Pressure Test



Do not open when an explosive atmosphere is present.

Ensure the gas supply has been isolated at the source before disconnecting the tubing from the equipment.

The test is to apply 100mbar of pressure to each gas inlet, including air, in turn as per the table associated to the model types below. Solenoids are to be toggled via the [Diagnostics Control Mode](#). A successful test is a pressure drop of less than 10mbar in a minute on each test point.

For each test, the ball valves on the 'Process Return' and 'Vent to Atmosphere' lines should be closed.

Note: Ensure the drain valve is closed when performing the pressure test.

Note: An additional two ball valves will be required if not installed on the 'Process Return' and



## Operating Manual

'Vent to Atmosphere' outlets as recommended during the installation.

### BG3K1 and BG3KE without an External Sensor

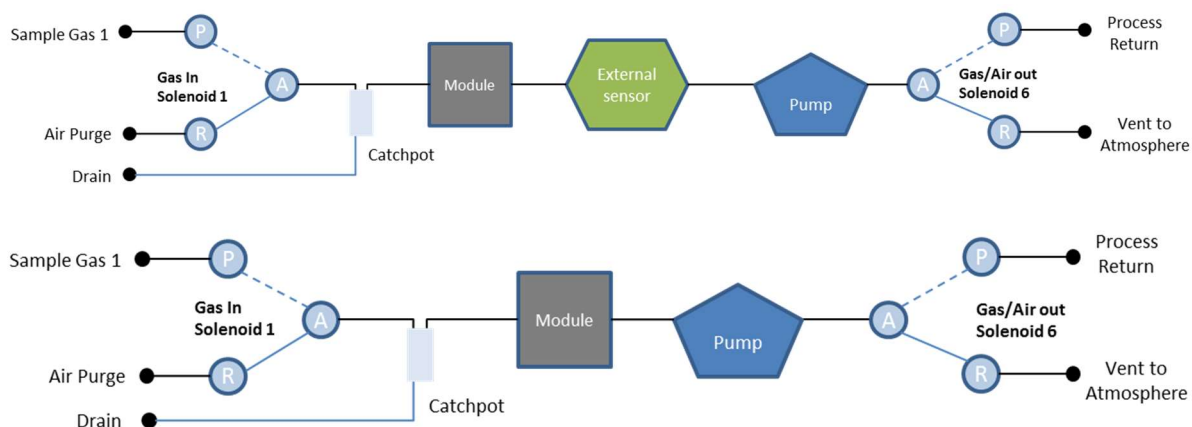

Apply pressure to:	Solenoid 1	Solenoid 6
Air Purge	OFF	OFF
Sample Gas 1	ON	ON

Note: Ensure the ball valves on the 'Process Return' and 'Vent to Atmosphere' lines are opened once testing is completed.

Note: When reattaching the sample pipes to the system, ensure all tube connections are tight and free from leaks.

If assistance is required, please contact your local distributor, or our technical support team at QED on +44(0)333 800 0088 or email [technical@qedenv.co.uk](mailto:technical@qedenv.co.uk).

### BG3K2

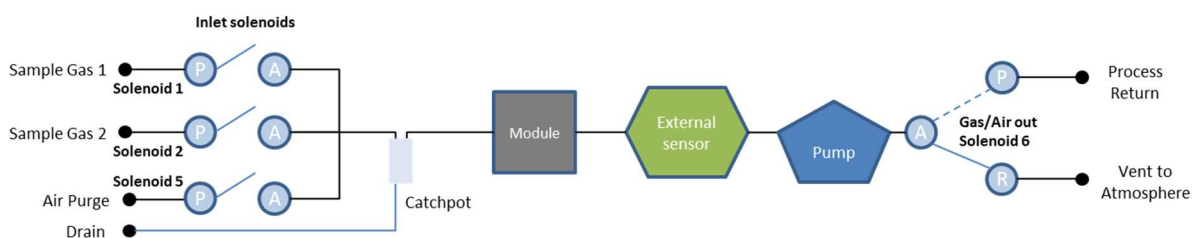

Apply pressure to:	Solenoid 1	Solenoid 2	Solenoid 5	Solenoid 6
Air Purge	OFF	OFF	ON	OFF
Sample Gas 1	OFF	OFF	OFF	OFF
Sample Gas 2	OFF	ON	OFF	ON

Note: Ensure the ball valves on the 'Process Return' and 'Vent to Atmosphere' lines are opened once testing is completed.

## Operating Manual

Note: When reattaching the sample pipes to the system, ensure all tube connections are tight and free from leaks.

If assistance is required, please contact your local distributor, or our technical support team at QED on +44(0)333 800 0088 or email [technical@qedenv.co.uk](mailto:technical@qedenv.co.uk).

### BG3K3

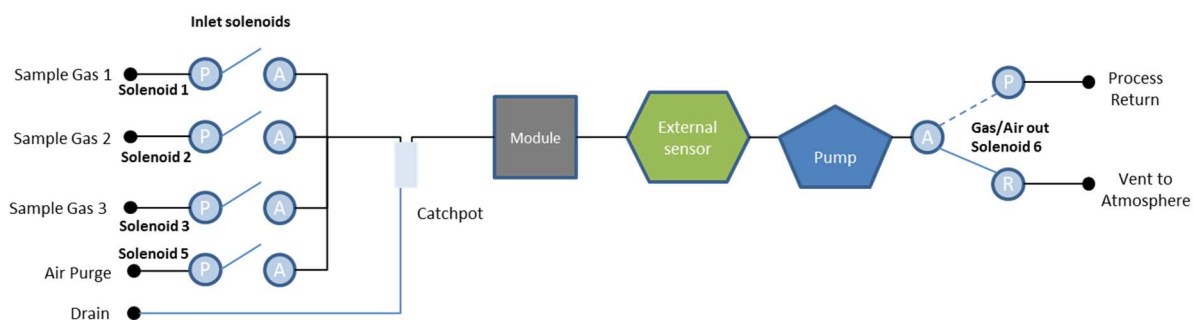

With hydrolysis option:

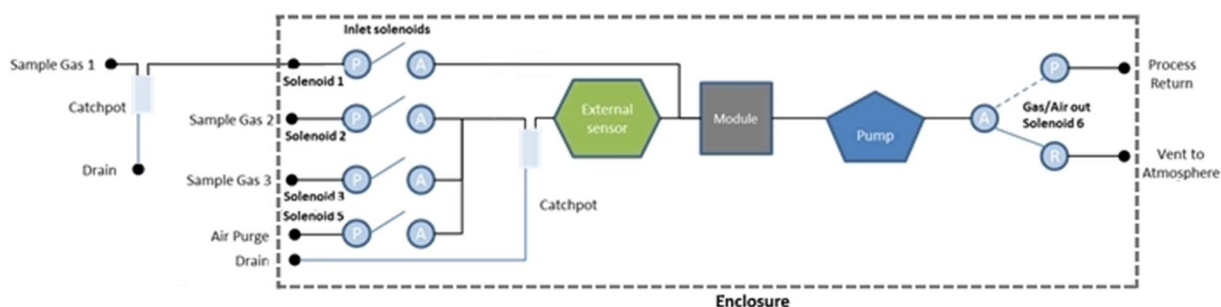

Apply pressure to:	Solenoid 1	Solenoid 2	Solenoid 3	Solenoid 5	Solenoid 6
Air Purge	OFF	OFF	OFF	ON	OFF
Sample Gas 1	OFF	OFF	OFF	OFF	OFF
Sample Gas 2	OFF	OFF	OFF	OFF	OFF
Sample Gas 3	OFF	OFF	ON	OFF	ON

Note: Ensure the ball valves on the 'Process Return' and 'Vent to Atmosphere' lines are opened once testing is completed.

Note: When reattaching the sample pipes to the system, ensure all tube connections are tight and free from leaks.

If assistance is required, please contact your local distributor, or our technical support team at QED on +44(0)333 800 0088 or email [technical@qedenv.co.uk](mailto:technical@qedenv.co.uk).

## Operating Manual

### BG3K4

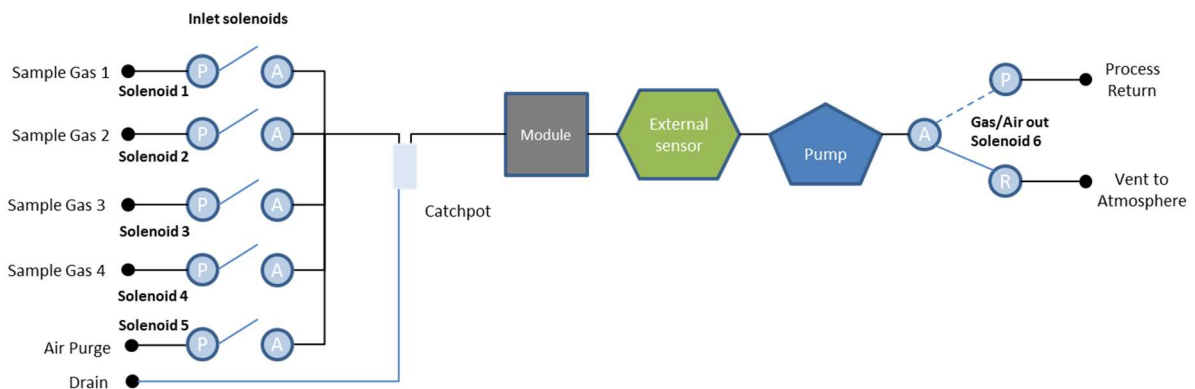

With hydrolysis option:

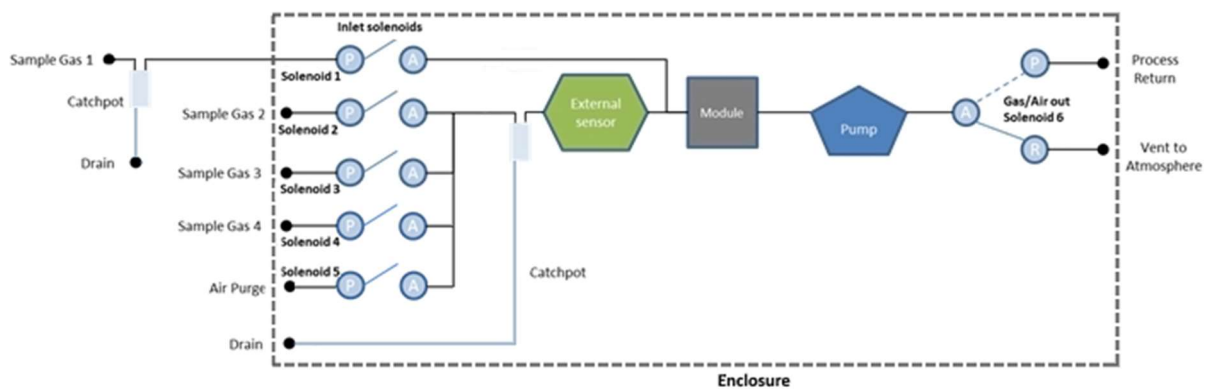

Apply pressure to:	Solenoid 1	Solenoid 2	Solenoid 3	Solenoid 4	Solenoid 5	Solenoid 6
Air Purge	OFF	OFF	OFF	OFF	ON	OFF
Sample Gas 1	OFF	OFF	OFF	OFF	OFF	OFF
Sample Gas 2	OFF	OFF	OFF	OFF	OFF	OFF
Sample Gas 3	OFF	OFF	OFF	OFF	OFF	OFF
Sample Gas 4	OFF	OFF	OFF	ON	OFF	ON

Note: Ensure the ball valves on the 'Process Return' and 'Vent to Atmosphere' lines are opened once testing is completed.

Note: When reattaching the sample pipes to the system, ensure all tube connections are tight and free from leaks.

If assistance is required, please contact your local distributor, or our technical support team at QED on +44(0)333 800 0088 or email [technical@qedenv.co.uk](mailto:technical@qedenv.co.uk).

## Operating Manual

### BG3KD

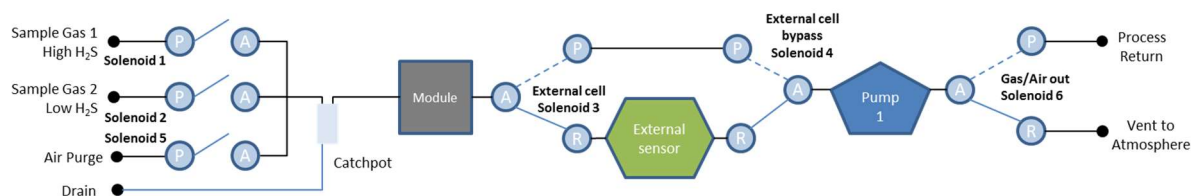

Apply pressure to:	Solenoid 1	Solenoid 2	Solenoid 3	Solenoid 4	Solenoid 5	Solenoid 6
Air Purge	OFF	OFF	OFF	OFF	ON	OFF
Sample Gas 1	OFF	OFF	OFF	OFF	OFF	OFF
Sample Gas 2	OFF	OFF	ON	ON	OFF	ON

Note: Ensure the ball valves on the 'Process Return' and 'Vent to Atmosphere' lines are opened once testing is completed.

Note: When reattaching the sample pipes to the system, ensure all tube connections are tight and free from leaks.

If assistance is required, please contact your local distributor, or our technical support team at QED on +44(0)333 800 0088 or email [technical@qedenv.co.uk](mailto:technical@qedenv.co.uk).

### BG3KE with an External Sensor

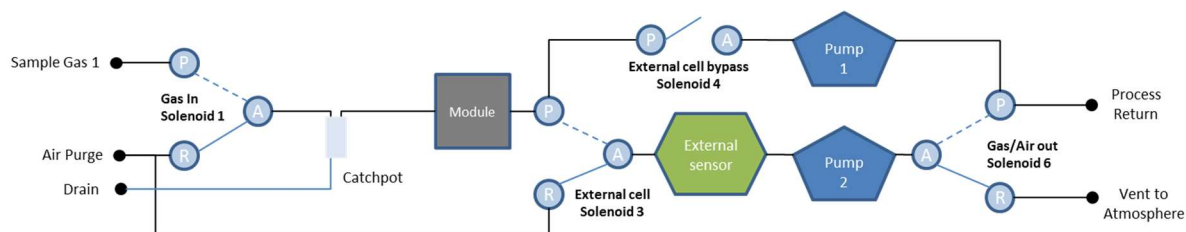

Apply pressure to:	Solenoid 1	Solenoid 3	Solenoid 4	Solenoid 6
Air Purge	OFF	OFF	OFF	OFF
Sample Gas 1	ON	OFF	ON	OFF

Note: Ensure the ball valves on the 'Process Return' and 'Vent to Atmosphere' lines are opened once testing is completed.

When reattaching the sample pipes to the system, ensure all tube connections are tight and free from leaks.

If assistance is required, please contact your local distributor, or our technical support team at QED on +44(0)333 800 0088 or email [technical@qedenv.co.uk](mailto:technical@qedenv.co.uk).

## Operating Manual

### Cleaning and Decontamination

The equipment must be isolated from the mains supply prior to cleaning or decontamination. The enclosure can be cleaned externally using a mild soapy water and non-abrasive cloth.

Should the need arise for the BIOGAS 3000 module to be returned for service, it is the responsibility of the owner to ensure that the module has been decontaminated or that QED has been made aware of any contaminants that may be present, prior to it being returned.



Only the exterior of the enclosure should require cleaning. Cleaning the interior could result in injury due to mains power being present.

High-pressure jet washers should not be used to clean the enclosure.

## Operating Manual

### SERVICE

#### General

The BIOGAS 3000 module should be regularly serviced to ensure correct and accurate operation. QED recommends a service and recalibration every **6 months**.

It is recommended that only qualified engineers service the BIOGAS 3000 module. Failure to observe this will result in the warranty becoming invalid.

**Note:** For further information on how to return your BIOGAS 3000 module for service, please contact your distributor or our service team at QED on +44(0)333 800 0088 or email [service@qedenv.co.uk](mailto:service@qedenv.co.uk).

#### Service Notifications

The BIOGAS 3000 uses two icons on the 'Gas Readings Screen' to notify the user that the module is due a service:



The service is due in 28 days



The service is overdue

In addition to the icons on screen, the service due date is a readable parameter in the Modbus, Profibus and Profinet registers, and is viewable in the [System Information](#) screen.

#### Replacement BIOGAS 3000 Module for Service – Hot Swap





The BIOGAS 3000 has been designed to avoid unnecessary downtime and a temporary BIOGAS 3000 module can be supplied during service upon request. Below are instructions on how to swap out the BIOGAS 3000 module for service.

Do not open when an explosive atmosphere is present.

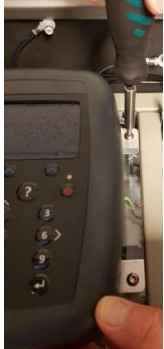

Mains voltages are present within the BIOGAS 3000 system and great care needs to be observed. If there is any uncertainty, seek advice from a professional or isolate the supply. Alternatively, contact your local distributor, or our technical support team at QED on +44(0)333 800 0088 or email [technical@qedenv.co.uk](mailto:technical@qedenv.co.uk) to arrange a site visit. (Please note a charge may be applicable.)

## Operating Manual

Op.	Image	Instruction
1		<p>Power off the module by holding the on/off key for two seconds.</p> <div style="border: 1px solid black; padding: 5px; margin-top: 10px;"> <p><b>Note:</b> This will freeze the outputs at their last known value.</p> </div>
2		<p>Disconnect the gas inlet and gas outlet tubing from the top of the BIOGAS 3000 module.</p>
3		<p>Disconnect the USB lead from the communications connector and the power supply lead from the power supply connector from the top of the BIOGAS 3000 module.</p>
4		<p>Remove the four screws securing the module mounting brackets to the pillars using a 4mm Allen key.</p> <div style="border: 1px solid black; padding: 5px; margin-top: 10px;"> <p><b>Note:</b> Keep the screws safe, as they will be required to secure the hot swap module.</p> </div>
5	<p>No image</p>	<p>Send the module to your distributor or our service team at QED.</p>
6		<p>Align the new module with the four pillars and secure in place using the four screws and 4mm Allen key. The screws must be tightened to 4 N·m.</p>

## Operating Manual



It is critical that the screws are torques to 4 N-m. Failure to tighten to this setting will invalidate the ATEX and IECEx certification.

7		<p>Reconnect the USB lead to the communications connector and the power supply lead to the power supply connector at the top of the BIOGAS 3000 module.</p>
8		<p>Reconnect the gas in and gas out tubing to the module.</p> <div style="border: 1px solid black; padding: 5px; margin-top: 10px;"> <p><b>Note:</b> Ensure that the couplings are fully pushed into the housing.</p> <p><b>Note:</b> The yellow tubing should connect to the yellow port on the module.</p> </div>



It is critical that the connections are fully secured to ensure that no gas leaks in to the main enclosure. It is recommended that a [Pressure Test](#) be completed to ensure the system is leak free.

9		<p>Power on the module by pressing the on/off key for two seconds.</p>
10	<div style="border: 1px solid black; padding: 5px;"> <p><b>First Time Configure</b></p> <p><b>You will now be lead through a first-time configuration.</b></p> <p>Any previous settings, if appropriate, will already be loaded, otherwise pre-defined default values will be provided.</p> <p>At the end you will be provided an opportunity to carry out a gas check on the equipment to prove its accuracy and rectify any inaccuracies with a calibration. Alternatively, pressing 'Exit' will begin the monitoring process.</p> <p style="text-align: right;"> <b>Continue</b> <small>V2.0.1091</small></p> </div>	<p>The hot swap module will pre-load the configuration from the Interface PCB and run the operator through a <a href="#">First Time Configuration</a>.</p>

**Note:** After replacing the BIOGAS 3000 module, QED recommend that a gas check be performed on the system to ensure it is still reading accurately. If required, a user calibration can also be performed; refer to the [Gas Check and Calibration](#) section of this operating manual for more information.



## Operating Manual

### PROBLEM SOLVING

This section discusses various problems that may be encountered, and warnings or error messages that the operator may receive during general operation of the BIOGAS 3000. For further assistance please contact your local distributor, or our technical support team at QED on +44(0)333 800 0088 or email [technical@qedenv.co.uk](mailto:technical@qedenv.co.uk).

#### Fault Detection

When switched on the instrument will perform a pre-determined self-test sequence taking approximately sixty seconds. During this time, many of the systems working parameters and settings are checked. In addition, during normal operation, similar parameters are checked to ensure the channels are valid.

There are two types of faults, critical and non-critical.

#### Non-Critical Faults

If a non-critical fault is detected after power on, a warning will be displayed in a summary screen:

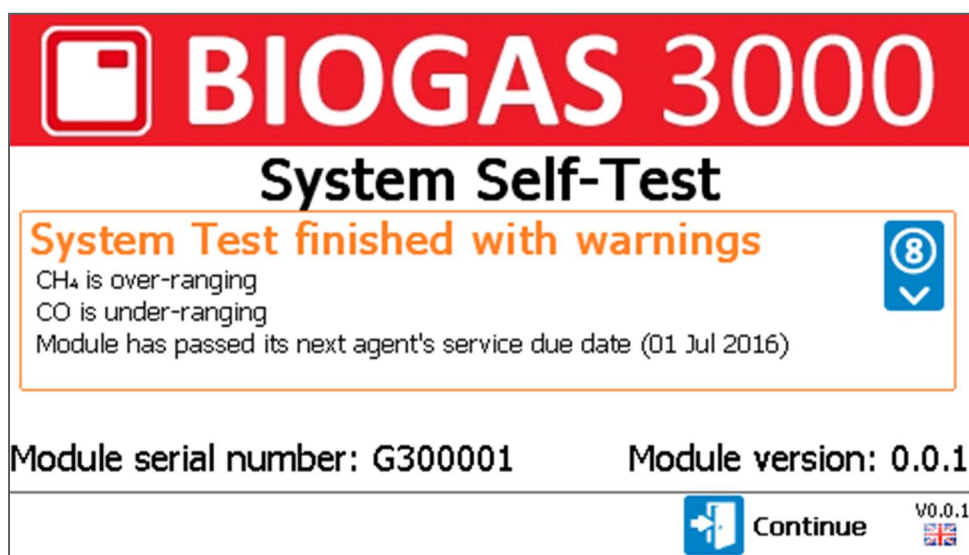

Screen 52 - Self-test with warnings

For non-critical faults at this stage, the user can continue by pressing the right soft key 'Continue'. The BIOGAS 3000 will continue automatically after thirty seconds if continue is not pressed.

In addition to [Screen 52 - Self-test with warnings](#), there will be a non-critical fault icon present on the 'Gas Readings Screen' during monitoring:



A non-critical fault does not stop the sampling process and this will continue as normal. Examples of non-critical faults are a channel under-ranging or the service being due.

Pressing the right soft key on the 'Gas Readings Screen' will display the non-critical faults the system

## Operating Manual

has detected.

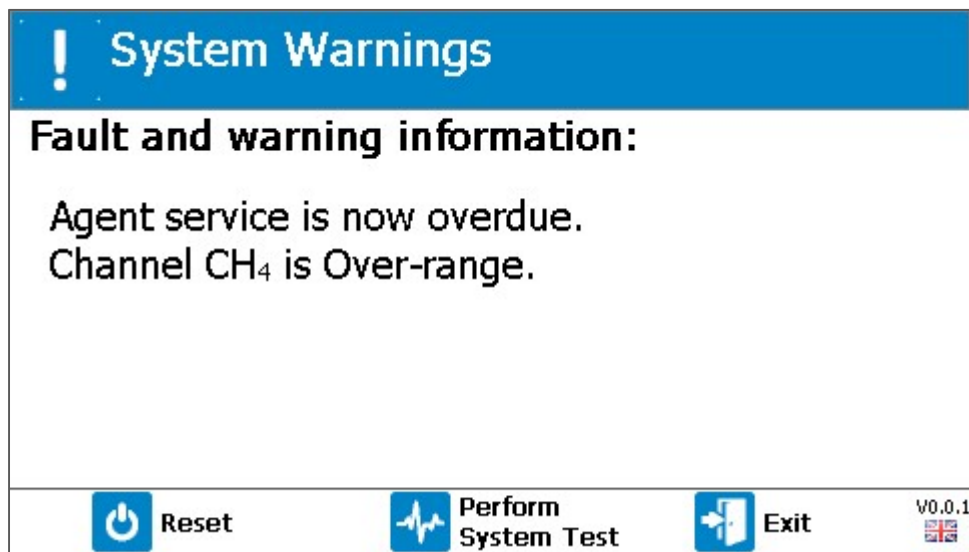

Screen 53 - System Warnings (non-critical faults)

From this screen:

- pressing the left soft key will 'Reset' the system and power cycle the BIOGAS 3000 module
- pressing the middle soft key will perform a system test. If the fault clears after this, monitoring will resume and the icon will be removed
- pressing the right soft key will 'Exit' and returns the operator to the 'Gas Readings Screen'.

### Critical Faults

If a critical fault is detected after power on, a warning will be displayed in a summary screen:

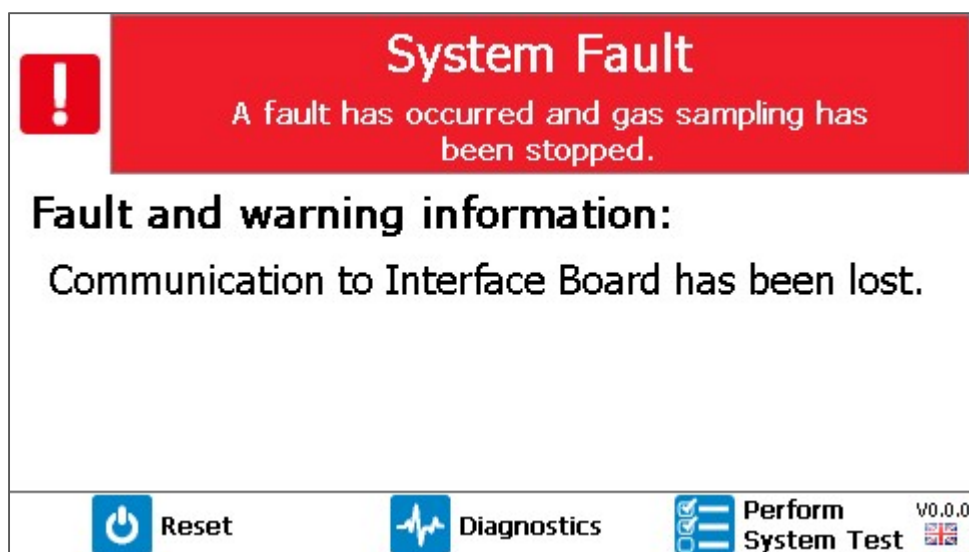

Screen 54 - System Fault

## Operating Manual

The difference between a non-critical fault and critical fault after the self-test is that the user cannot proceed until the fault is rectified. In addition, the fault relay is de-energised to inform the operator of a problem.

Examples of critical faults are a loss of communications to the Interface PCB and low flow. If a critical fault occurs during the monitoring process, the process will be immediately stopped, the outputs will be frozen at their last known value, the fault relay will be de-energised, and an error message posted on screen.

From this screen:

- pressing the left soft key will 'Reset' the system and power cycle the BIOGAS 3000 module
- pressing the middle soft key will access the 'Diagnostics' screen. This may be required if seeking technical support
- pressing the right soft key will perform a system test. If the fault clears after this, monitoring will resume, the message will be cleared, and the fault relay energised.

After a critical fault occurs, the system will perform a self-test every fifteen minutes on four occasions to check if the fault has cleared. In the event it is still present, the self-test will then occur every 24-hours until user intervention or the fault has cleared.

### System Will Not Power On

Ensure the switched mains supply is turned on and check that the LEDs are illuminated on the 24Vdc and 12Vdc power supplies. If they are not, check the mains fuse (fuse 1) and replace if necessary.



Do not remove fuses whilst energised.

If the problem persists, please contact your local distributor, or our technical support team at QED on +44(0)333 800 0088 or email [technical@qedenv.co.uk](mailto:technical@qedenv.co.uk).

### Module Will Not Power On

Ensure there is power to the system by checking that the LEDs are illuminated on the 24Vdc and 12Vdc power supplies. If they are not, check the mains fuse (fuse 1) and replace if necessary.

If they are illuminating, it can take up to one minute for the BIOGAS 3000 module to power on. If it does not turn on at the point power to the system is applied, please wait one minute before pressing any keys on the module.

If after one minute the module has not powered on, check the fuse for the supply to the module (fuse 2) and replace if necessary.

Finally, check fuse 3, which provides 12Vdc to the Interface PCB, which in turn supplies the power to the module.

## Operating Manual



Do not remove fuses whilst energised.

If the problem persists, please contact your local distributor, or our technical support team at QED on +44(0)333 800 0088 or email [technical@qedenv.co.uk](mailto:technical@qedenv.co.uk).

#### Module Lock-Up

In the rare event that the BIOGAS 3000 'locks up' and will not recognise button presses, the system should automatically power cycle the module due to a loss of communications.

If this does not occur or fix the problem, isolate the supply to the system and leave the system switched off for 60 seconds. After this duration, turn the power back on and check the systems operation.

If the problem persists, please contact your local distributor, or our technical support team at QED on +44(0)333 800 0088 or email [technical@qedenv.co.uk](mailto:technical@qedenv.co.uk).

#### Under and Over Range Codes

If a reading is under range (i.e. below zero) it will display 'less than' chevrons (<<<). This can occur if:

- a channel has been incorrectly user calibrated
- the BIOGAS 3000 module has been damaged (e.g. during transit)
- the BIOGAS 3000 module has drifted out of calibration or it is due a factory calibration.

If a reading is over range (i.e. above the maximum allowed value) it will display 'more than' chevrons (>>>). This can occur:

- for the same reasons as an under range error
- if the channel is reading more than its acceptable limit (e.g. CH<sub>4</sub> > 100%)
- due to potential cross gas effects.

In most circumstances, a return to factory settings (see [Restore to Factory](#)) and performing a user calibration (see [Gas Check and Calibration](#)) will resolve the error. If the error is not cleared by performing these tasks, please contact your local distributor, or our technical support team at QED on +44(0)333 800 0088 or email [technical@qedenv.co.uk](mailto:technical@qedenv.co.uk).

#### Analogue Outputs Not Working

Please refer to section [4-20mA Outputs](#) in this operating manual to ensure the outputs have been wired correctly. If the wiring method is not suitable for the input systems configuration, please contact your local distributor, or our technical support team at QED on +44(0)333 800 0088 or email [technical@qedenv.co.uk](mailto:technical@qedenv.co.uk).

## Operating Manual

If the system is wired correctly, ensure the analogue outputs have been configured correctly; refer to [Configure Analogue Outputs](#) for more information.

Check that your 4-20mA input channel is being interpreted correctly; refer to [4-20mA Scaling](#).

Finally, check fuse 5, which is used to provide power to the 4-20mA loop.

If the problem persists, please contact your local distributor, or our technical support team at QED on +44(0)333 800 0088 or email [technical@qedenv.co.uk](mailto:technical@qedenv.co.uk).

### Modbus Outputs Not Working

Please refer to section [Configure Modbus Slave](#) in this operating manual and ensure that the configuration of the Modbus port is correct and that the wiring is correct as per [Wiring Diagram 2 – Modbus](#).

**Note: If the BIOGAS 3000 is last on the bus, ensure the termination is set to 'On'. Likewise, if it is not, ensure the termination is set to 'Off'.**

In addition, also check that no two nodes on the bus have the same slave address. If this is the case, the BIOGAS 3000 slave address can be changed by referring to section [Configure Modbus Slave](#) in this operating manual.

If the problem persists, please contact your local distributor, or our technical support team at QED on +44(0)333 800 0088 or email [technical@qedenv.co.uk](mailto:technical@qedenv.co.uk).

### Low Flow / Flow Fail

If a flow fail occurs, this is classified as a critical fault and sampling will be stopped.

A flow fail occurs when there is not enough gas flowing through the BIOGAS 3000 module. This can be for a number of reasons:

- You are sampling against a vacuum outside of the range of the system
- There are blockages in the system
- There is a gas leak in the system.

Firstly, check that all gas in and gas out valves are open, the drain valve is closed, and the calibration valve is closed.

If the valves are in the correct position and the problem persists:

- Ensure that the system is not operating against a vacuum outside of its operating range. Refer to the latest technical specification (available at [www.geotechuk.com](http://www.geotechuk.com)) for further information.
- Empty the catchpot of any contents (see [Emptying the Catchpot](#)).
- Replace inline PTFE filter (see [Replacing the Inline PTFE Filter](#)).

## Operating Manual

- Replace the catchpot filter (see [Replacing the Catchpot Filter](#)).
- Visually check for damaged pipes or obvious signs of leaks.
- Perform a [Pressure Test](#).
- Retest the system.

If after performing the above steps the problem is still present, please contact your local distributor, or our technical support team at QED on +44(0)333 800 0088 or email [technical@qedenv.co.uk](mailto:technical@qedenv.co.uk).

### Fuses



The use of alternative fuses may affect the safety of the apparatus and will invalidate the hazardous area certification.

Ensure the power is isolated before removing the protective cover and replacing fuses. Once replaced, the protective cover will need to be refitted.

Please refer to the following table for the designation and location of each fuse together with its type and rating:

Designation	Circuit	Rated voltage	Rated current	Type
FS1	Mains input Power supplies Heater	250v	3.15A	20mm time delay, ceramic
FS2	24Vdc pumps Drain pump Reed switch	250v	1.25A	20mm time delay, ceramic
FS3	4-20mA loop Relay control External sensor	250v	500mA	20mm time delay, ceramic
FS4	Solenoids	250V	1A	20mm time delay, ceramic
FS5	24Vdc supply	250V	2A	20mm time delay, ceramic
FS6	BIOGAS 3000 module supply	250v	1A	20mm time delay, ceramic
FS7	12Vdc supply to Interface PCB	250V	1A	20mm time delay, ceramic

Note: Please contact your local distributor, or our sales team at QED on +44(0)333 800 0088 or email [sales@qedenv.co.uk](mailto:sales@qedenv.co.uk) for further information.

## Operating Manual

### User Calibration Explained

#### General

User calibration is a means of optimising the performance of the BIOGAS 3000 system to the current operating conditions such as temperature and pressure as well as correcting for analyser drift caused by the infrared source.

User calibration has two operations, zero and span, and each may be performed individually. However, for a complete user calibration both must be completed.

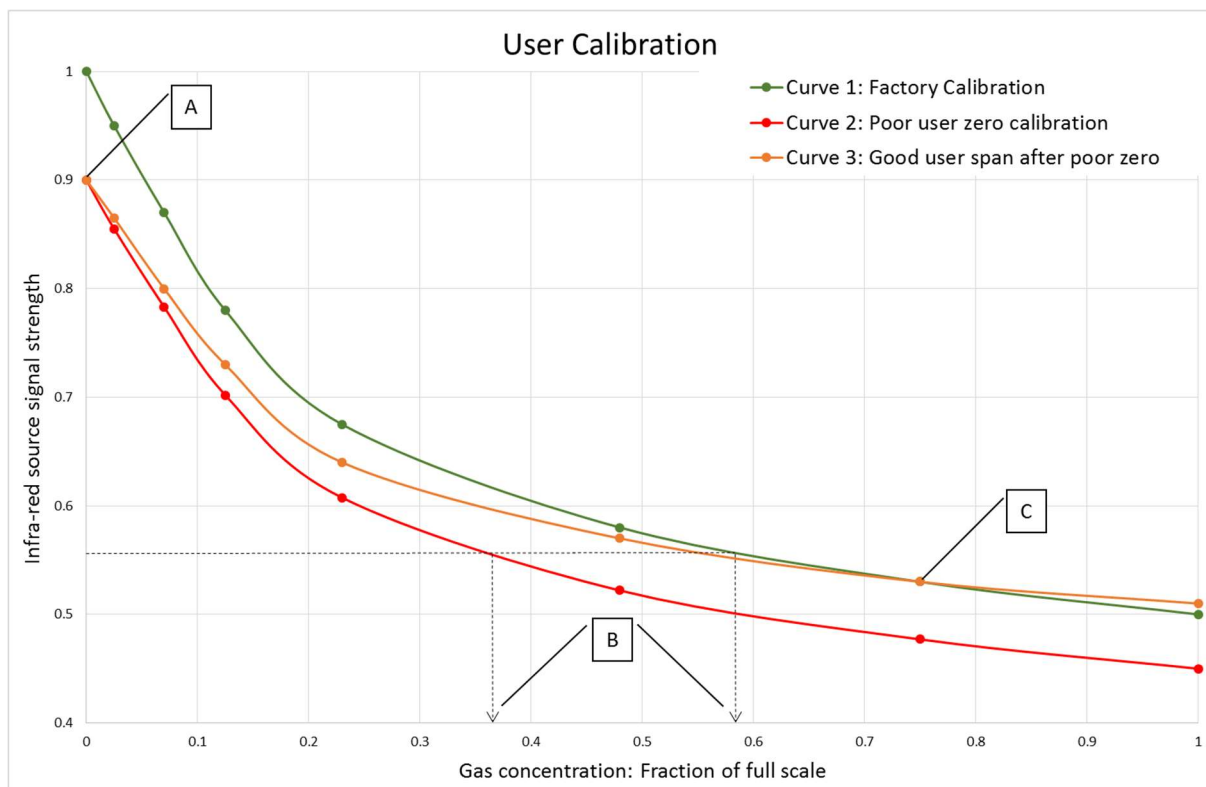

Graph 1 - User calibration explained

#### Factory Calibration

When the BIOGAS 3000 module is factory calibrated, a stable gas curve is generated (see curve 1 on [Graph 1 - User calibration explained](#)). This curve is then used to determine the gas concentration based on the infrared signal strength after being absorbed by the gas.

#### User Zero Calibration

A zero calibration is used to correct the entire curve for the infrared source and filter variations caused by aging and induced drift due to dirt and other contaminants. If done correctly, there is often no need to complete a span calibration, as the new curve will follow closely to the factory calibration curve (curve 1 on [Graph 1 - User calibration explained](#)).

## Operating Manual

The zero calibration is very sensitive and a rushed or poor calibration, (such as the target gas still being present), will result in a zero error; see point A on curve 2 of [Graph 1 - User calibration explained](#). This also produces an error throughout the remainder of the curve proportional to signal strength, but the effect on the span is significant, see point B on [Graph 1 - User calibration explained](#).

**Note:** To perform an accurate user calibration it is critical that a good user zero has been performed. QED recommend that this be done in nitrogen in order to guarantee that none of the gas of interest is present.

**Note:** To obtain a good zero it may be necessary to flow nitrogen for several minutes, especially if the BIOGAS 3000 system has been subjected to high levels of gas previously, in order to ensure there are no remains of the target gas present. On the BIOGAS 3000, this would result in leaving the system for several minutes before pressing 'check' during the gas check process.

### User Span Calibration

A span calibration is used to optimise the analyser at the span calibration concentration (see point C on [Graph 1 - User calibration explained](#)) for the current operational conditions. It corrects the span point but leaves the zero unadjusted (this will be left at the last user zero if this has been performed) and should be done at the concentration of interest in the particular application.

If the user zero is poor and the span calibration is good, it will correct the gas curve for the point of interest, but other points on the curve could be incorrect, see curve 3 on [Graph 1 - User calibration explained](#).

### Trouble Shooting

#### User Zero Calibration Failed

Three possible reasons for this are that:

- the BIOGAS 3000 module is trying to zero to a level which is outside the predetermined range set when the module was last factory calibrated
- the gas is not stable i.e. it is still purging out the measured gas
- the system is not seeing a flow of gas.

To rectify this:

- ensure the BIOGAS 3000 module contains none of the gas that is being zeroed by flushing through with nitrogen, or clean ambient air if this is not available and repeat a user zero calibration
- ensure the correct zero calibration has been selected (nitrogen, fresh air, or a mix with none of the target gas present) and retry
- ensure the flow regulator on the gas bottle is open (if being used).



## Operating Manual

If after performing the above steps the problem is still present, please contact your local distributor, or our technical support team at QED on +44(0)333 800 0088 or email [technical@gedenv.co.uk](mailto:technical@gedenv.co.uk).

### User Span Calibration Failed

Check the span target (see [Gas Mixtures](#)) is set to the value given on the calibration bottle. If not, correct and re-span the channel.

In addition, check that the flow regulator on the gas bottle is open.

If the problem persists, repeat an entire user calibration by zeroing the channel prior to performing a span calibration.

**Note:** Always ensure that the on-screen reading has begun to stabilise before pressing 'Check'. If you notice that the reading is still changing after the elapsed time, use the 'Retry' function and perform the span calibration again.

If after performing the above steps the problem is still present, please contact your local distributor, or our technical support team at QED on +44(0)333 800 0088 or email [technical@gedenv.co.uk](mailto:technical@gedenv.co.uk).

### Channel Outside of Limits

A channel outside of its limits to be calibrated is indicated by the  icon in the 'User Calibration' screen. The cause of this is either:

- The channel is under-ranging or over-ranging
- The current user reading is too far from the target

In both scenarios, perform a [Restore to Factory](#), followed by a zero or span check.

If after performing the above steps the problem is still present, please contact your local distributor, or our technical support team at QED on +44(0)333 800 0088 or email [technical@gedenv.co.uk](mailto:technical@gedenv.co.uk).

### CH<sub>4</sub> Reading Low and O<sub>2</sub> Reading High

If you believe that the CH<sub>4</sub> reading is lower than you expect or the O<sub>2</sub> reading is higher than you expect, there could be two reasons for this:

- There could be a leak in the tubing and when sampling you could be drawing in air and diluting the sample. Refer to the [Pressure Test](#) section of this operating manual for instructions on how to pressure test the BIOGAS 3000 system.
- The BIOGAS 3000 has drifted since its calibration and may be due a user calibration; see section [Gas Check and Calibration](#) of this operating manual for further information.

If after performing the above steps the problem is still present, please contact your local distributor, or our technical support team at QED on +44(0)333 800 0088 or email [technical@gedenv.co.uk](mailto:technical@gedenv.co.uk).

### BIOGAS 3000 WARRANTY TERMS AND CONDITIONS



## BIOGAS 3000 Warranty Terms and Conditions

QED will repair or replace (at QED's discretion) any goods supplied by the company in respect to defects arising within **12 months** for components related to the system and **3 years** for components related to the module from date of purchase or delivery, whichever is later, provided that:

- The defect is due to faulty parts or workmanship provided by QED.
- Proof of delivery/purchase must be provided to QED for any claims. This includes a QED sales order, invoice, or delivery note.
- All warranty repairs can only be carried out by QED or its authorised agents. In certain circumstances, permission may be granted by QED for the owner to replace a supplied part under warranty.
- Any repair or replacement component under warranty will not extend the warranty period of the system.
- Products must have been returned for service and calibration as recommended by QED or its authorised agents.
- Where replacement parts have been supplied by QED under warranty, the replaced parts must be returned to QED. If not returned, QED reserve the right to charge for the replacement part.
- If no fault is found an investigation charge may apply.
- QED's Technical support **MUST** be notified in the event of a pending warranty claim. They will then issue a returns reference number that must be included in any return. Failure to provide this will void any warranty claim.

#### The following is not included:

- Normal wear and tear of parts that might wear out over time, or be consumed, is not covered. Parts not covered include, but not limited to, the suppression diodes, PTFE filter, coalescing filter, electrochemical cells, and tubing.
- A service is not part of a warranty claim.
- Accidental damage, including dropping during installation.
- Damage as a result of vandalism.
- Faults arising from use of the equipment that is not in accordance with standard operating procedures laid out in QED's operating manual.
- Faults arising from use of the equipment in unsuitable applications.
- Repairs or alterations carried out by parties other than QED, its authorised agents, or under the instruction of QED.
- Any data stored on the equipment that may be lost.
- A claim due to a failure in maintaining the system in accordance with the operating manual.
- A claim as a result of poor quality or inadequate repairs.
- Any business related losses such as income, profits, and contracts (as far as the law allows).

#### The following voids the warranty:

- When non-approved QED parts have been used for repair or maintenance.
- When parts are added, or alterations made, to the system outside the scope of the operating manual.

[www.qedenv.com](http://www.qedenv.com)

BG3000WARRANTY Iss.02  
© QED Environmental Systems Ltd.

## Operating Manual



- The BIOGAS 3000 module has been opened, unless by QED approved service centres (where applicable).
- The BIOGAS 3000 system has been opened in poor weather conditions that have resulted in damage to any of its components.
- The equipment has been stored or installed outside of the operating range and environmental conditions determined in the operating manual.
- The equipment has not been maintained in accordance with the operating manual.

#### Service Warranty:

- QED offer a three-month warranty period, following a QED service, to cover any defects that have arisen because of that service.



#### Note

Warranty repair is only granted after an investigation by QED.

For assistance in determining if your equipment qualifies for warranty investigation, please contact your local distributor, or our technical support team at QED on +44(0)333 800 0088 or email [technical@qedenv.co.uk](mailto:technical@qedenv.co.uk).

For extended warranty options, please contact your local distributor, or our sales team at QED on +44(0)333 800 0088 or email [sales@qedenv.co.uk](mailto:sales@qedenv.co.uk).

For any other queries please contact your local distributor, or our sales team at QED on +44(0)333 800 0088 or email [sales@qedenv.co.uk](mailto:sales@qedenv.co.uk).

QED Environmental Systems reserve the right to update these terms and conditions without notice.

## Operating Manual

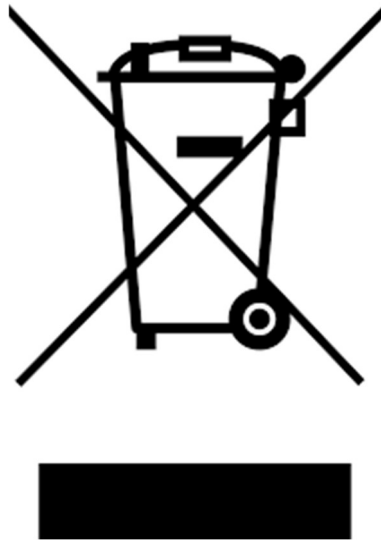
**WEEE COMPLIANCE**

The wheeled bin symbol displayed on electrical equipment supplied by QED signifies that the apparatus must not be disposed of through the normal municipal waste stream but through a registered recycling scheme.

The Waste Electrical and Electronic Equipment Directive (WEEE) make producers responsible in meeting their obligations, with the fundamental aim of reducing the environmental impact of electrical and electronic equipment at the end of its life.

QED is registered with the Environmental Agency as a producer and has joined a recycling scheme provider that manage and report on our electrical waste on our behalf.

**Note:** When your instrument is at the end of its life, please contact your local distributor, or our sales team at QED on +44(0)333 800 0088 or email [sales@qedenv.co.uk](mailto:sales@qedenv.co.uk), who will advise you on the next step in order to help us meet our obligations.

## Operating Manual

### DECLARATION OF CONFORMITY

## EU Declaration of Conformity

**This Declaration of Conformity is issued under the sole responsibility of the manufacturer:**

QED Environmental Systems  
Cyan Park – Unit 3  
Jimmy Hill Way  
Coventry  
CV2 4QP  
UNITED KINGDOM

**Product:** BIOGAS 3000

**Type of equipment:** Fixed position landfill and biogas analyser



**The BIOGAS 3000 described above is in conformity with the relevant Union harmonisation legislation:**

2014/34/EU: Equipment and protective systems intended for use in potentially explosive atmospheres (ATEX)

QED Environmental Systems performed assessment against:

- BS EN ISO 80079-36:2016

Issuing certificate number QED 20ATEX0001U.

CSA Group Netherlands B.V. (2813) performed assessment against:

- EN 60079-0:2012/A11:2013
- EN 60079-15:2010

Issuing certificate number Sira 16ATEX4203X

2014/30/EU: Electromagnetic capability (EMC)

- EN 50270:2006
- EN 61000-3-2:2014
- EN 61000-3-3:2013

2014/35/EU: Electrical equipment designed for use within certain voltage limits (LVD)

- EN 61010-1:2010

2011/65/EU: Restriction of the use of hazardous substances in electrical and electronic equipment (RoHS)

## Operating Manual

**In addition, the following International requirements are met:**



International Electrotechnical Commission system for certification to standards relating to equipment for use in explosive atmospheres (IECEx System)

- IEC60079-0:2011 Ed.6.0
- IEC60079-15:2010 Ed.4.0

Issuing certificate number: IECEx SIR 16.0069X

**Signed for and on behalf of:**

A handwritten signature in black ink, appearing to read 'C. Millar', with a long horizontal line extending to the right.

**Name:** Mr. Craig Millar

**Position:** Engineering Manager

**Done at:** QED Environmental Systems

**On:** 16<sup>th</sup> February 2021

## Operating Manual

### GLOSSARY OF TERMS

Term	Definition
Air purge	Process used to clear out gas from the tubing within the BIOGAS 3000 system and used as part of a user zero in air.
Baro	The atmospheric pressure at the given location, measured in milli bar (mb/mbar).
CH <sub>4</sub>	Methane
CO <sub>2</sub>	Carbon dioxide
CO	Carbon monoxide
Catchpot filter	The filter used to drop water droplets from the sample gas into the catchpot.
Current source	The BIOGAS 3000 supplies the source to the 4-20mA loop. Other configurations are available.
Electrochemical gas sensor	A method of gas detection that works based on a chemical reaction with the target gas e.g. H <sub>2</sub> S.
External gas sensor	An electrochemical gas sensor incorporated in to an assembly external to the BIOGAS 3000 module but part of the overall system. It allows an additional gas to be monitored by the equipment.
Factory settings	Default settings pre-set at time of manufacture or service.
Firmware	Firmware is the term by which the internal module software is known and is not accessible by the client. Firmware is updated to the latest version when the analyser is returned to QED or an approved agent for servicing. The firmware can be updated by the end user using a QED approved power source and the Geotech Firmware Updater.
H <sub>2</sub>	Hydrogen
H <sub>2</sub> S	Hydrogen sulphide
Hazard	A potential source of harm.
Hazardous live	Capable of rendering an electric shock or electric burn.
Infrared source	The component used to provide a source of infrared light that can be absorbed by the gas.
Infrared source drift	The component used to provide a source of infrared light has changed its brightness, and may not have been fully compensated by the reference channel. This may be due to age or contamination.
Inline PTFE filter	The component used to help protect the BIOGAS 3000 module from water ingress.
Material safety data sheet	A document that contains information about a particular substance. Commonly known as MSDS.
Modbus	Modbus is a serial communications protocol and is a means of connecting industrial electronic devices.
Pollution Degree 3	Conductive pollution occurs, or dry, non-conductive pollution occurs which becomes conductive due to condensation which is expected.
Polymeric materials	Organic material, natural or synthetic, with high molecular weight made of repetitive structural units. Examples include wool and PVC.
Pump	Used to draw the gas sample from the monitoring point to the BIOGAS 3000.
Reference channel	An infrared channel that has no sensitivity to the gas of interest that is used as a baseline for the CH <sub>4</sub> and CO <sub>2</sub> absorption.